



**НОГОЗ®**

**ELECTRIC**

Э к с п е р т   в   о б л а с т и   о с в е щ е н и я

2020–2021

К А Т А Л О Г





[www.horozelectric.ru](http://www.horozelectric.ru)



**HOROZ®**

**ELECTRIC**



 [www.instagram.com/horoz\\_official](https://www.instagram.com/horoz_official)  
 [www.facebook.com/horoz.official](https://www.facebook.com/horoz.official)  
 [www.vk.com/horoz.official](https://www.vk.com/horoz.official)

 **KaçmazGrup**  
<http://horozelectric.ru>



Светодиодные лампы, трубки, капсулы.....	2	Детекторы, датчики управления светом, таймеры, беспроводные переключатели.....	127
<b>Светодиодные встраиваемые светильники.....</b>	<b>15</b>	<b>Диммеры, выключатели, розетки.....</b>	<b>130</b>
Светодиодные накладные светильники.....	25	Оборудование для управления и защиты электродвигателей .....	132
<b>Светодиодные встраиваемые панели.....</b>	<b>26</b>	<b>Патроны.....</b>	<b>136</b>
Системы трекового освещения.....	29	Стартеры, клипсы, кабель, изолента .....	137
<b>Светодиодные подвесные светильники и люстры.....</b>	<b>37</b>	<b>Удлинители, соединители, клеммы.....</b>	<b>138</b>
Светодиодные подвесы.....	53	TEB Electric.....	
<b>Декоративные подвесы.....</b>	<b>54</b>	<b>Колодки и удлинители.....</b>	<b>140</b>
Гирлянды.....	57	Вилки и выключатели.....	151
<b>Декоративные настенно-потолочные светильники.....</b>	<b>60</b>	<b>Розетки-тройники.....</b>	<b>155</b>
Светодиодные потолочные светильники.....	65	Удлинители кабеля.....	156
<b>Светодиодные настенные светильники.....</b>	<b>65</b>	<b>Пластиковые вентиляторы..</b>	<b>157</b>
Светодиодные потолочные светильники.....	66	Потолочные светильники с датчиком движения.....	158
<b>Светильники для ванной комнаты, подсветки картин и зеркал.....</b>	<b>71</b>	<b>Водонепроницаемые светильники.....</b>	<b>159</b>
Торшеры.....	76	Светодиодные светильники..	160
<b>Настольные лампы.....</b>	<b>77</b>	<b>Светильники под лампочку.</b>	
Ночные светильники.....	82	Светильники с двумя патронами.....	177
<b>Линейные светильники.....</b>	<b>83</b>	<b>Светильники (квадраты).....</b>	<b>178</b>
Пыле-влагозащищённые светильники.....	84	Садово-парковые светильники.....	180
<b>Садово-парковые светильники.....</b>	<b>101</b>	<b>Боксы под автоматические выключатели.....</b>	<b>184</b>
Светильники на солнечных батареях.....	112		
<b>Встраиваемые грунтовые и лестничные светильники.....</b>	<b>115</b>		
Светодиодные ленты и драйверы.....	118		
<b>RGB-контроллеры, неон.....</b>	<b>120</b>		
Драйверы, гирлянды.....	123		
<b>Аварийные светильники и фонари.....</b>	<b>124</b>		



**HOROZ ELECTRIC**

LED Лампы / LED Трубки / LED Капсулы

**PREMIER**

- 175-250V / 50-60Hz
- Срок службы 25 000 Часов
- 3000K / 4200K / 6400K

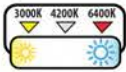

**NEW PRODUCT**



	PREMIER-7	PREMIER-12	PREMIER-14	PREMIER-17	PREMIER-20	PREMIER-22
	001-006-0007	001-006-0012	001-006-0014	001-006-0017	001-006-0020	001-006-0022
Power	: 7 W	: 12 W	: 14 W	: 17 W	: 20 W	: 22 W
Luminous Flux	: 700 lm	: 1200 lm	: 1400 lm	: 1700 lm	: 2000 lm	: 2200 lm
Sizes (mm)	: A:55 B:95	: A:60 B:108	: A:60 B:105	: A:60 B:111	: A:65 B:120	: A:70 B:140

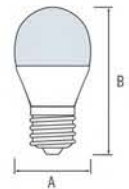

**HOROZ ELECTRIC**

LED Лампы  
LED Трубки  
LED Капсулы



3 6 0

**INFINITY**

001 018 0008

- 220-240V / 50-60Hz
- Срок службы 25 000 Часов
- 600 Lm
- 3000K / 4200K / 6400K



360°



D I M M A B L E

**EXPERT-10**

001 021 0010

- 220-240V / 50-60Hz
- Срок службы 25 000 Часов
- 900 lm
- 3000K / 4200K / 6400K



DIMMABLE



## DURAMAX-12

- 100-250V / 50-60Hz
- Срок службы 30 000 Часов
- 1080 lm
- 6400K
- 3,7V 2200mAh Li-ion Battery
- Emergency Work: 4.5W – 500 lm

001 055 0012

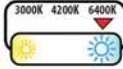

Rechargeable  
Emergency  
LED  
Bulb



Emergency Lighting  
Duration: 3 Hours

**NEW  
PRODUCT**

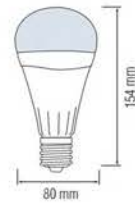

## FONIX

- 175-250V / 50-60Hz
- Срок службы 25 000 Часов
- 3000K / 4200K / 6400K

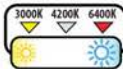

	FONIX-4	FONIX-6	FONIX-8
	001-001-0004	001-001-0006	001-001-0008
Power	4 W	6 W	8 W
Luminous Flux	250 lm	390 lm	630 lm



## PLUS

- 175-250V / 50-60Hz
- Срок службы 25 000 Часов
- 3000K / 4200K / 6400K

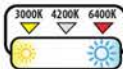

	PLUS-4	PLUS-6	PLUS-8
	001-002-0004	001-002-0006	001-002-0008
Power	4 W	6 W	8 W
Luminous Flux	250 lm	390 lm	630 lm



## D I M M A B L E

### VISION-6

001 022 0006

- 220-240V / 50-60Hz
- Срок службы 25 000 Часов
- 390 lm
- 3000K / 4200K / 6400K





### ULTRA

- 175-250V / 50-60Hz
- Срок службы 25 000 Часов
- 3000K / 4200K / 6400K

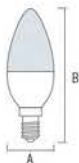
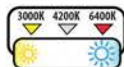

ULTRA-4	ULTRA-6	ULTRA-10	ULTRA-12
001-003-0004	001-003-0006	001-003-0010	001-003-0012

Power	: 4 W	6 W	10 W	12 W
Luminous Flux	: 250 lm	480 lm	1000 lm	1200 lm
Sizes (mm)	: A: 37 B: 100	A: 37 B: 100	A: 37 B: 110	A: 37 B: 110



### CRAFT

- 175-250V / 50-60Hz
- Срок службы 25 000 Часов
- 3000K / 4200K / 6400K

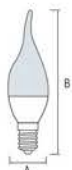
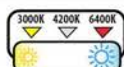

CRAFT-4	CRAFT-6	CRAFT-10	CRAFT-12
001-004-0004	001-004-0006	001-004-0010	001-004-0012

Power	: 4 W	6 W	10 W	12 W
Luminous Flux	: 250 lm	480 lm	1000 lm	1200 lm
Sizes (mm)	: A: 37 B: 125	A: 37 B: 125	A: 37 B: 135	A: 37 B: 135



### ELITE

- 175-250V / 50-60Hz
- Срок службы 25 000 Часов
- 3000K / 4200K / 6400K
- E14 & E27

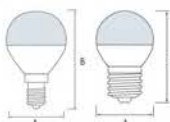
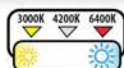

ELITE-4	ELITE-6	ELITE-10	ELITE-12
001-005-0004	001-005-0006	001-005-0010	001-005-0012

Power	: 4 W	6 W	10 W	12 W
Luminous Flux	: 250 lm	480 lm	1000 lm	1200 lm
Sizes (mm)	: A: 45 B: 78	A: 45 B: 78	A: 45 B: 88	A: 45 B: 88



### REFLED

- 175-250V / 50-60Hz
- Срок службы 25 000 Часов
- 4200K

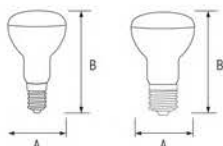
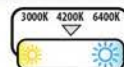

REFLED-4	REFLED-6	REFLED-10	REFLED-12
001-039-0004	001-040-0006	001-041-0010	001-042-0012

Power	: 4 W	6 W	10 W	12 W
Luminous Flux	: 210 lm	480 lm	720 lm	1000 lm
Lamp Holder	: E14	E14	E27	E27
Sizes	: A: 39 B: 68	A: 50 B: 86	A: 63 B: 100	A: 80 B: 115



## TORCH

- 175-250V / 50-60Hz
- Срок службы 25 000 Часов

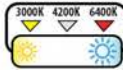

	TORCH-20	TORCH-30	TORCH-40	TORCH-50	TORCH-80	TORCH-100
	001-016-0020	001-016-0030	001-016-0040	001-016-0050	001-016-0080	001-016-0100
Power	20 W	30 W	40 W	50 W	80 W	100 W
Color Temperature	3000K/4200K/6400K	3000K/4200K/6400K	3000K/4200K/6400K	3000K/4200K/6400K	6400K	6400K
Lamp Holder	E27	E27	E27	E27	E27	E27 / E40
Luminous Flux	2000 lm	3000 lm	4000 lm	5000 lm	8000 lm	10000 lm
Sizes (mm)	A: 80 B: 150	A: 101 B: 179	A: 119 B: 209	A: 139 B: 239	A: 139 B: 250	A: 160 B: 285

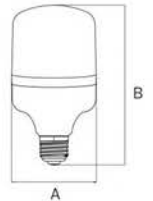

## UFO PRO

- 175-250V / 50-60Hz
- Срок службы 25 000 Часов
- 6400K

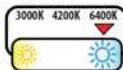

	UFO PRO-30	UFO PRO-50	UFO PRO-70
	001-056-0030	001-056-0050	001-056-0070
Power	30 W	50 W	70 W
Luminous Flux	3000 lm	5000 lm	7000 lm
Sizes (mm)	A: 135 B: 115	A: 170 B: 140	A: 195 B: 160

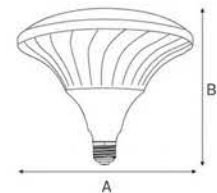

## UFO-15

001 044 0015

- 160-250V / 50-60Hz
- Срок службы 25 000 Часов
- 900 lm
- 4200K

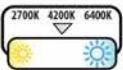

## GLOBE

- 175-250V / 50-60Hz
- Срок службы 25 000 Часов
- 3000K / 4200K / 6400K

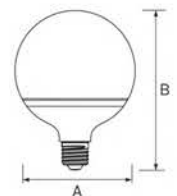
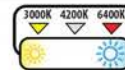

	GLOBE-16	GLOBE-20
	001-019-0016	001-020-0020
Power	16 W	20 W
Luminous Flux	1400 lm	1650 lm
Sizes (mm)	A: 95 B: 136.5	A: 120 B: 161



**FIREFLUX**

- 100-250V / 50-60Hz
- Average Life: 25.000 Hrs
- 117 lm
- 1500K

001 048 0005

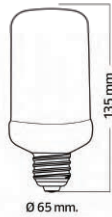
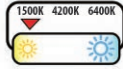

**3 Modes**



Flame Mode



General Lighting Mode



Breathing Mode



**PINE**

- 220-240V / 50-60Hz
- Average Life: 20.000 Hrs

001 059 0002

**NEW PRODUCT**



- 6400K 236 lm
- RED 19 lm
- AMBER 154 lm
- BLUE 32 lm
- GREEN 187 lm
- PINK 175 lm



**RAINBOW**

- 220-240V / 50-60Hz
- Average Life: 20.000 Hrs

001 017 0001

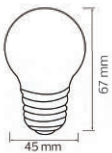

105 lm



34 lm



68 lm



12 lm



120 lm



**SPECTRA**

- 175-250V / 50-60Hz
- Average Life: 20.000 Hrs

001 017 0003

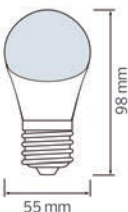

315 lm



102 lm



205 lm



38 lm



250 lm



**NEW PRODUCT**





**HOROZ ELECTRIC**

LED Лампы / LED Трубки / LED Капсулы

**TRIO-R**

001 065 0036

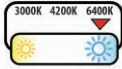

- 100-265V / 50-60Hz
- Average Life: 25.000 Hrs
- 3200 lm
- 6400K



**DAISY**

001 061 0040



- 160-250V / 50-60Hz
- Average Life: 25.000 Hrs

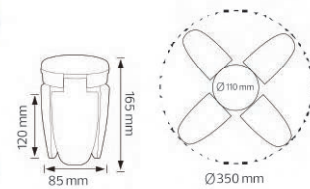
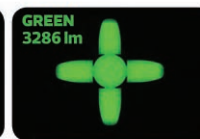

**LED TUBE**

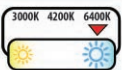

- 175-250V / 50-60Hz
- Average Life: 25.000 Hrs
- 6400K



	LED TUBE-60 002-001-0009	LED TUBE-120 002-001-0018	LED TUBE-150 002-001-0024
Power	9 W	18 W	24 W
Luminous Flux	750 lm	1450 lm	2400 lm
Length (mm)	L: 600	L: 1200	L: 1500



## FILAMENT CANDLE

- 220-240V / 50-60Hz
- Срок службы 20 000 Часов
- 2700K / 4200K

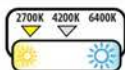

FILAMENT CANDLE-4	FILAMENT CANDLE-6
001-013-0004	001-013-0006

Power	:	4 W	6 W
Luminous Flux	:	420 lm	630 lm

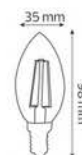

## FILAMENT FLAME

- 220-240V / 50-60Hz
- Срок службы 20 000 Часов
- 2700K / 4200K

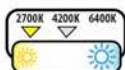

FILAMENT FLAME-4	FILAMENT FLAME-6
001-014-0004	001-014-0006

Power	:	4 W	6 W
Luminous Flux	:	420 lm	630 lm



## FILAMENT GLOBE

- 220-240V / 50-60Hz
- Срок службы 20 000 Часов
- 2700K / 4200K

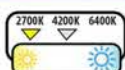

FILAMENT GLOBE-6	FILAMENT GLOBE-8	FILAMENT GLOBE-10
001-015-0006	001-015-0008	001-015-0010

Power	:	6 W	8 W	10 W
Luminous Flux	:	630 lm	840 lm	1050 lm

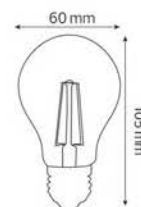

**HORGOZ ELECTRIC**

LED Лампы / LED Трубки / LED Капсулы

**TOLEDO**

- 220-240V / 50-60Hz
- Срок службы 20 000 Часов

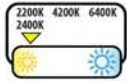
**NEW PRODUCT**

AMBER COLOR



TITANIUM COLOR

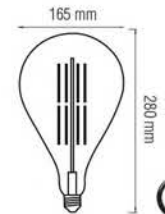

FILAMENT LED

TOLEDO

001-049-0008

Power	:	<b>8 W</b>
Luminous Flux	:	620 lm (Amber) / 250 lm (Titanium)
Color Temperature	:	2200K (Amber) / 2400K (Titanium)

**GINZA**

- 220-240V / 50-60Hz
- Срок службы 20 000 Часов

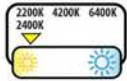
**NEW PRODUCT**

TITANIUM COLOR



AMBER COLOR

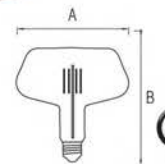

FILAMENT LED

GINZA

001-050-0008

GINZA-XL

001-050-0008

Power	:	<b>8 W</b>	<b>8 W</b>
Luminous Flux	:	620 lm (Amber) / 250 lm (Titanium)	620 lm (Amber) / 250 lm (Titanium)
Color Temperature	:	2200K (Amber) / 2400K (Titanium)	2200K (Amber) / 2400K (Titanium)
Sizes (mm)	:	A: 180 B: 190	A: 230 B: 200

**ENIGMA**

- 220-240V / 50-60Hz
- Срок службы 20 000 Часов

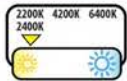
**NEW PRODUCT**

AMBER COLOR



TITANIUM COLOR

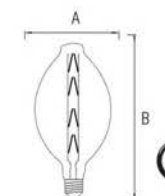

FILAMENT LED

ENIGMA

001-051-0008

ENIGMA-XL

001-051-0008

Power	:	<b>8 W</b>	<b>8 W</b>
Luminous Flux	:	620 lm (Amber) / 250 lm (Titanium)	620 lm (Amber) / 250 lm (Titanium)
Color Temperature	:	2200K (Amber) / 2400K (Titanium)	2200K (Amber) / 2400K (Titanium)
Sizes (mm)	:	A: 120 B: 225	A: 185 B: 345

**PARADOX**

■ 220-240V / 50-60Hz  
■ Срок службы 20 000 Часов

**PARADOX-XL**

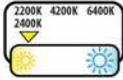

**NEW  
PRODUCT**

TITANIUM  
COLOR

AMBER  
COLOR

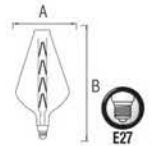

FILAMENT LED

	PARADOX	PARADOX-XL
	001-052-0008	001-052-0008

Power	: 8 W	8 W
Luminous Flux	: 620 lm (Amber) / 250 lm (Titanium)	620 lm (Amber) / 250 lm (Titanium)
Color Temperature	: 2200K (Amber) / 2400K (Titanium)	2200K (Amber) / 2400K (Titanium)
Sizes (mm)	: A:120 B: 270	A:188 B: 400

**ORIGAMI**

■ 220-240V / 50-60Hz  
■ Срок службы 20 000 Часов

**ORIGAMI-XL**

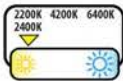

**NEW  
PRODUCT**

AMBER  
COLOR

TITANIUM  
COLOR

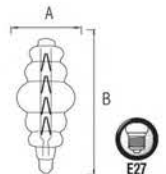

FILAMENT LED

	ORIGAMI	ORIGAMI-XL
	001-053-0008	001-053-0008

Power	: 8 W	8 W
Luminous Flux	: 620 lm (Amber) / 250 lm (Titanium)	620 lm (Amber) / 250 lm (Titanium)
Color Temperature	: 2200K (Amber) / 2400K (Titanium)	2200K (Amber) / 2400K (Titanium)
Sizes (mm)	: A:120 B: 270	A:180 B: 400

**ELLIPTIC**

■ 220-240V / 50-60Hz  
■ Срок службы 20 000 Часов

**ELLIPTIC-XL**

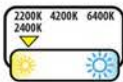

**NEW  
PRODUCT**

TITANIUM  
COLOR

AMBER  
COLOR

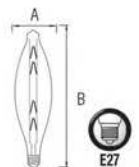
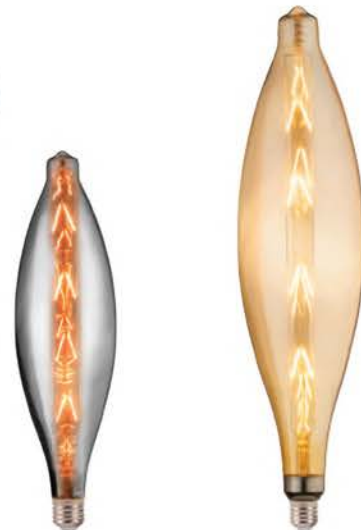

FILAMENT LED

	ELLIPTIC	ELLIPTIC-XL
	001-054-0008	001-054-0008

Power	: 8 W	8 W
Luminous Flux	: 620 lm (Amber) / 250 lm (Titanium)	620 lm (Amber) / 250 lm (Titanium)
Color Temperature	: 2200K (Amber) / 2400K (Titanium)	2200K (Amber) / 2400K (Titanium)
Sizes (mm)	: A:95 B: 340	A:115 B: 460

**RUSTIC VINTAGE**

- 220-240V / 50-60Hz
- Срок службы 20 000 Часов
- 2200K

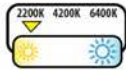
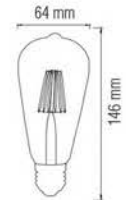
**AMBER COLOR****RUSTIC VINTAGE - 4**

001-029-0004

**RUSTIC VINTAGE - 6**

001-029-0006

Power	:	<b>4 W</b>	<b>6 W</b>
Luminous Flux	:	360 lm	540 lm

**RUSTIC GLOBE**

- 220-240V / 50-60Hz
- Срок службы 20 000 Часов
- 2200K

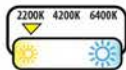
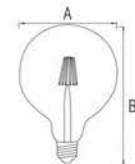
**AMBER COLOR****RUSTIC GLOBE - 4**

001-030-0004

**RUSTIC GLOBE - 6**

001-030-0006

Power	:	<b>4 W</b>	<b>6 W</b>
Luminous Flux	:	360 lm	540 lm
Sizes (mm)	:	A: 95 B: 128	A: 125 B: 172

**RUSTIC TUBE**

- 220-240V / 50-60Hz
- Срок службы 20 000 Часов
- 2200K

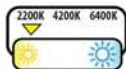
**AMBER COLOR****RUSTIC TUBE - 6**

001-033-0006

**RUSTIC TUBE - 8**

001-033-0008

Power	:	<b>6 W</b>	<b>8 W</b>
Luminous Flux	:	540 lm	720 lm
Sizes (mm)	:	A: 30 B: 185	A: 30 B: 235

**RUSTIC STAR - 6**

001 031 0006

- 220-240V / 50-60Hz
- Срок службы 20 000 Часов
- 540 lm
- 2200K

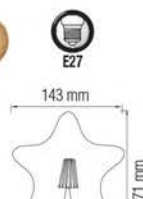
**AMBER COLOR****6W****RUSTIC HEART - 6**

001 032 0006

- 220-240V / 50-60Hz
- Срок службы 20 000 Часов
- 540 lm
- 2200K

**AMBER COLOR****6W**

## RUSTIC DIAMOND

- 220-240V / 50-60Hz
- Срок службы 20 000 Часов
- 2200K

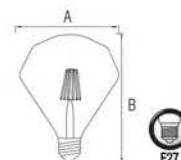
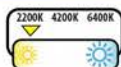

	RUSTIC DIAMOND - 4	RUSTIC DIAMOND - 6
	001-034-0004	001-034-0006

Power	:	4 W	6 W
Luminous Flux	:	360 lm	540 lm
Sizes (mm)	:	A: 95 B: 128	A: 120 B: 155

## RUSTIC CRYSTAL

- 220-240V / 50-60Hz
- Срок службы 20 000 Часов
- 2200K

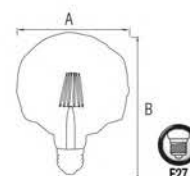
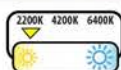

	RUSTIC CRYSTAL - 4	RUSTIC CRYSTAL - 6
	001-036-0004	001-036-0006

Power	:	4 W	6 W
Luminous Flux	:	360 lm	540 lm
Sizes (mm)	:	A: 95 B: 120	A: 125 B: 160

## RUSTIC TWIST

- 220-240V / 50-60Hz
- Срок службы 20 000 Часов
- 2200K

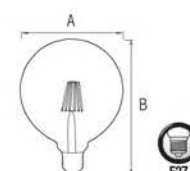
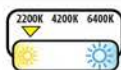

	RUSTIC TWIST - 4	RUSTIC TWIST - 6
	001-038-0004	001-038-0006

Power	:	4 W	6 W
Luminous Flux	:	360 lm	540 lm
Sizes (mm)	:	A: 95 B: 120	A: 125 B: 160

## RUSTIC PYRAMID - 6

001 035 0006

- 220-240V / 50-60Hz
- Срок службы 20 000 Часов
- 540 lm
- 2200K

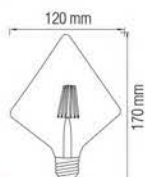

## RUSTIC MERIDIAN - 6

001 037 0006

- 220-240V / 50-60Hz
- Срок службы 20 000 Часов
- 540 lm
- 2200K

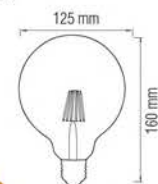



### PETA

- 220-240V / 50-60Hz
- Срок службы 25 000 Часов
- 2700K / 4200K / 6400K

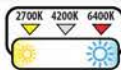

PETA-4	PETA-6	PETA-8	PETA-10
001-045-0004	001-045-0006	001-045-0008	001-045-0010

Power	:	4 W	6 W	8 W	10 W
Luminous Flux	:	330 lm	480 lm	680 lm	800 lm
Sizes (mm)	:	A: 15,9 B: 48,7	A: 15,7 B: 60,5	A: 18,4 B: 55	A: 18,4 B: 63

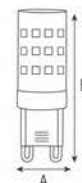

### DECO

- 220-240V / 50-60Hz
- Срок службы 25 000 Часов
- 2700K / 4200K / 6400K

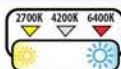

DECO-3	DECO-7
001-023-0003	001-023-0007

Power	:	3 W	7 W
Luminous Flux	:	300 lm	630 lm
Sizes (mm)	:	A: 16 B: 48	A: 16,3 B: 55,5

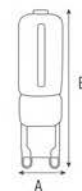

### MEGA

- 220-240V / 50-60Hz
- Срок службы 25 000 Часов
- 2700K / 6400K

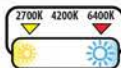

MEGA-3	MEGA-5
001-011-0003	001-011-0005

Power	:	3 W	5 W
Luminous Flux	:	180 lm	230 lm



## D I M M A B L E

### NANO

- 220-240V / 50-60Hz
- Срок службы 25 000 Часов
- 2700K / 6400K

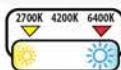

NANO-2	NANO-3
001-008-0002	001-008-0003

Power	:	1.5 W	3 W
Luminous Flux	:	105 lm	210 lm

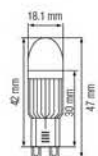
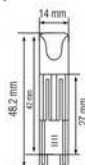

### EXA-3

- 220-240V / 50-60Hz
- Срок службы 25 000 Часов
- 300 lm
- 2700K / 4200K / 6400K

001 047 0003







### GIGA-4

- 220-240V / 50-60Hz
- Срок службы 25 000 Часов
- 360 lm
- 6400K

001 046 0004









### MICRO

- 220-240V / 50-60Hz
- Срок службы 25 000 Часов
- 2700K / 6400K

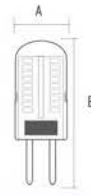
2700K 4200K 6400K

	MICRO-2	MICRO-3
Code	001-010-0002	001-010-0003
Power	1.5 W	3 W
Luminous Flux	90 lm	150 lm
Sizes (mm)	A: 12 B: 34	A: 12 B: 38



### MINI

- 12V DC
- Срок службы 25 000 Часов
- 60 lm
- 2700K / 6400K

001 009 0002







### MIDI

- 12V DC
- Срок службы 25 000 Часов
- 110 lm
- 2700K / 6400K

001 012 0002







### TERA-2

- 220-240V / 50-60Hz
- Срок службы 25 000 Часов
- 200 lm
- 2700K / 4200K / 6400K

001 024 0002









### D I M M A B L E

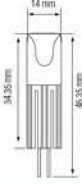

### PIKO

- 220-240V / 50-60Hz
- Срок службы 25 000 Часов
- 2700K / 6400K

2700K 4200K 6400K

	PIKO-2	PIKO-3
Code	001-007-0002	001-007-0003
Power	1.5 W	3 W
Luminous Flux	105 lm	210 lm





LED светильники,  
встраиваемые



**BELLA**

016 042 0003



CHROME

MAT CHROME

WHITE

BLACK

ROSE

- 85-265V / 50-60Hz
- 125 lm
- 4200K
- Срок службы 30 000 Часов



**BIANCA**

016 036 0003



WHITE

MAT CHROME

- 85-265V / 50-60Hz
- 210 lm
- 4200K
- Срок службы 30 000 Часов

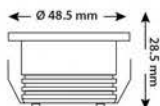

**MIRANDA**

016 004 0003

HL 666L



CHROME

MAT CHROME

- 220-240V / 50-60Hz
- 260 lm
- 4200K
- Срок службы 30 000 Часов



**SILVIA**

016 039 0001



**LAURA**

016 038 0001



WHITE

MAT CHROME

- 85-265V / 50-60Hz
- 70 lm
- 4200K
- Срок службы 30 000 Часов

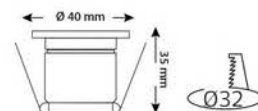
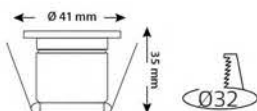

**MONICA**

016 003 0001

**CHROME**  
**MAT CHROME**

- 220-240V / 50-60Hz
- 4200K
- 80 lm
- Срок службы 30 000 Часов







**NADIA**

016 027 0001

**MAT CHROME**

- 220-240V / 50-60Hz
- 4200K
- 70 lm
- Срок службы 30 000 Часов







**RITA**

016 037 0003

**WHITE**

- 85-265V / 50-60Hz
- 210 lm
- 4200K
- Срок службы 30 000 Часов







**LUNA**

016 041 0003

**WHITE**

- 220-220V / 50-60Hz
- 210 lm
- 4200K
- Срок службы 30 000 Часов
- Встраиваемый + накладной
- Простая установка







**ANGELA**

016 002 0002

**MAT CHROME**

- 220-240V / 50-60Hz
- 100 lm
- 4200K
- Срок службы 30 000 Часов







**LISA**

016 031 0003







**JULIA**

016 032 0003

**WHITE**

- 220-240V / 50-60Hz
- Срок службы 30 000 Часов
- 125 lm
- 4200K







**HOROS ELECTRIC**

LED светильники, встраиваемые

**GABRIEL**

016 029 0006

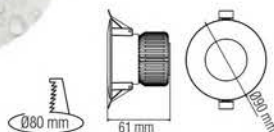
**JESSICA**

016 030 0006

**WHITE**

- 100-240V / 50-60Hz
- Срок службы 30 000 Часов
- 410 lm
- 4200K

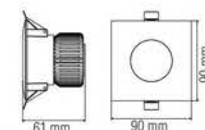
**VICTORIA**

- AC 220-240V / 50-60Hz
- Срок службы 30 000 Часов
- 2700K / 4200K / 6400K

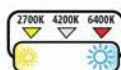

	VICTORIA-3	VICTORIA-5
	016-007-0003	016-007-0005

Power	:	3 W	5 W
Luminous Flux	:	230 lm	300 lm

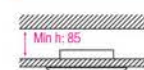
**MAT CHROME****WHITE****MELISA**

- AC 220-240V / 50-60Hz
- Срок службы 30 000 Часов
- 2700K / 4200K / 6400K

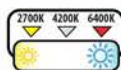

	MELISA-3	MELISA-5
	016-008-0003	016-008-0005

Power	:	3 W	5 W
Luminous Flux	:	230 lm	300 lm

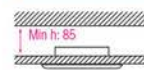
**MAT CHROME****WHITE****LILYA**

- AC 220-240V / 50-60Hz
- Срок службы 30 000 Часов
- 2700K / 4200K / 6400K

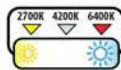

	LILYA-3	LILYA-5
	016-009-0003	016-009-0005

Power	:	3 W	5 W
Luminous Flux	:	222 lm	335 lm

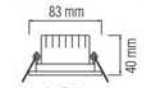
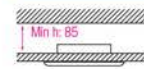
**MAT CHROME****WHITE**

### VALERIA

- 85-265V / 50-60Hz
- Срок службы 30 000 Часов
- 4200K

WHITE

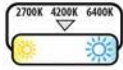

VALERIA-5	VALERIA-7	VALERIA-9
016-040-0005	016-040-0007	016-040-0009

Power	: 5 W	7 W	9 W
Luminous Flux	: 400 lm	560 lm	720 lm
Cutting Diameter (mm)	: Ø50	Ø70	Ø95
Sizes (mm)	: A: 20 B: 62 C: 55	A: 20 B: 82 C: 55	A: 20 B: 102 C: 55

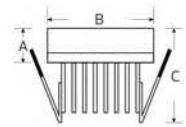

### SONIA-5

016 035 0005

WHITE

- 100-240V / 50-60Hz
- Срок службы 30 000 Часов
- 350 lm
- 6400K



### LILY

016 018 0030

WHITE

- 220-240V / 50-60Hz
- Срок службы 30 000 Часов
- 1447 lm
- 6500K

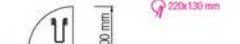

### VERA

- AC 220-240V / 50-60Hz
- Срок службы 30 000 Часов
- 2700K / 6400K

MAT CHROME

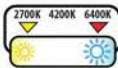

VERA-3	VERA-6	VERA-18
016-011-0003	016-011-0006	016-011-0018

Power	: 3 W	6 W	18 W
Luminous Flux	: 135 lm	270 lm	720 lm
Cutting Diameter (mm)	: Ø70	Ø100	Ø170
Sizes (mm)	: A: 83 B: 40	A: 120 B: 65	A: 192 B: 75

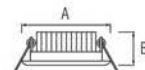

### ELENA

- AC 220-240V / 50-60Hz
- Срок службы 30 000 Часов
- 2700K / 6400K

MAT CHROME

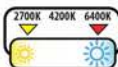

ELENA-1	ELENA-3	ELENA-6
016-010-0001	016-010-0003	016-010-0006

Power	: 1 W	3 W	6 W
Luminous Flux	: 45 lm	135 lm	270 lm
Cutting Diameter (mm)	: Ø50	Ø75	Ø110
Sizes (mm)	: A: 60 B: 20	A: 90 B: 40	A: 120 B: 65

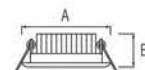

## ADRIANA

- 220–240V / 50–60Hz
- Срок службы 30 000 Часов
- 2700K / 6400K

WHITE

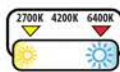

ADRIANA-5	ADRIANA-10	ADRIANA-15
016-021-0005	016-021-0010	016-021-0015

Power	: 5 W	2x5 W	3x5 W
Luminous Flux	: 368 lm	2x368 lm	3x368 lm
Cutting Size (mm)	: 73x73	90x155	90x240
Sizes (mm)	: A: 93 B: 44 C: 93	A: 175 B: 44 C: 93	A: 255 B: 44 C: 93

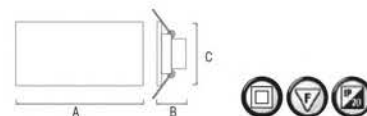

## VERONICA

- 220–240V / 50–60Hz
- Срок службы 30 000 Часов
- 2700K / 6400K

WHITE

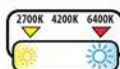

VERONICA-10	VERONICA-20	VERONICA-30
016-022-0010	016-022-0020	016-022-0030

Power	: 10 W	2x10 W	3x10 W
Luminous Flux	: 539 lm	2x539 lm	3x539 lm
Cutting Size (mm)	: 90x90	100x205	100x315
Sizes (mm)	: A: 120 B: 80 C: 120	A: 230 B: 80 C: 120	A: 340 B: 80 C: 120

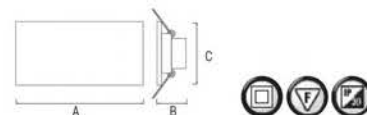

## SABRINA

- 220–240V / 50–60Hz
- Срок службы 30 000 Часов
- 2700K / 6400K

WHITE

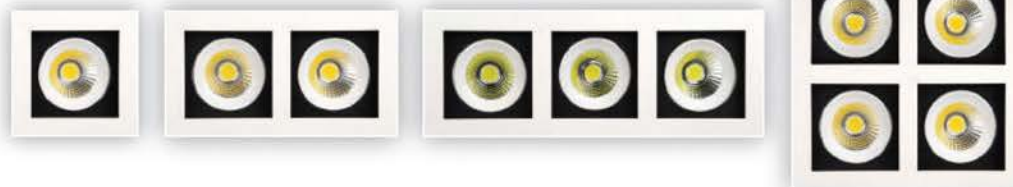
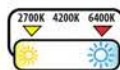

SABRINA-8	SABRINA-16	SABRINA-24	SABRINA-32
016-023-0008	016-023-0016	016-023-0024	016-023-0032

Power	: 8 W	2x8 W	3x8 W	4x8 W
Luminous Flux	: 371 lm	2x371 lm	3x371 lm	4x371 lm
Cutting Size (mm)	: 90x90	81x170	81x255	170x170
Sizes (mm)	: A: 100 B: 67 C: 100	A: 185 B: 67 C: 100	A: 270 B: 67 C: 100	A: 185 B: 67 C: 185

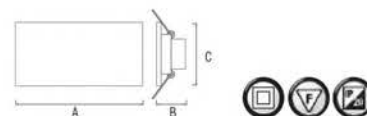



**HOROSZ ELECTRIC**

LED светильники, встраиваемые



**STELLA**

- 165-260V / 50-60Hz
- Average Life: 25.000 Hrs
- 6400K

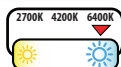

FRAMELESS

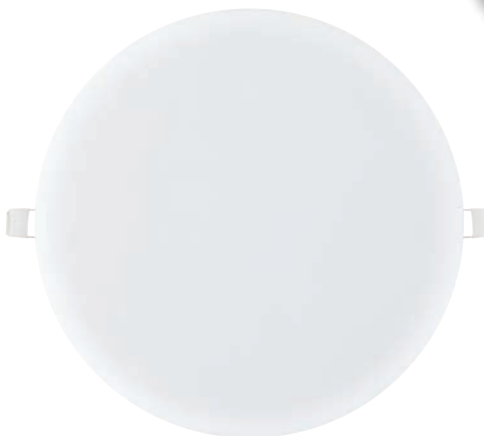

	STELLA-8	STELLA-16	STELLA-20	STELLA-30
	016-052-0008	016-052-0016	016-052-0020	016-052-0030
Power	8 W	16 W	20 W	30 W
Luminous Flux	455 lm	950 lm	1375 lm	2260 lm
Cutting Diameter (mm)	75	112	163	215
Sizes (mm)	A: 91 B: 19	A: 121 B: 19	A: 173 B: 19	A: 223 B: 19

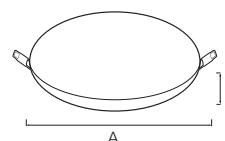

**HOROSZ ELECTRIC****LED светильники, встраиваемые****MARIA**

- 220-240V / 50-60Hz
- Срок службы 30 000 Часов
- 3000K/4200K/6400K

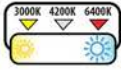
**WHITE**

MARIA-6	MARIA-12	MARIA-15
016-015-0006	016-015-0012	016-015-0015

Power	: 6 W	12 W	15 W
Luminous Flux	: 600 lm	1200 lm	1500 lm
Cutting Size (mm)	: 73X73	125X125	165X165
Sizes (mm)	: A: 96 B: 35	A: 160 B: 40	A: 198 B: 40

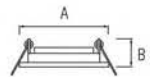
**CLARA**

- 220-240V / 50-60Hz
- Срок службы 30 000 Часов
- 3000K/4200K/6400K

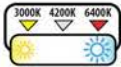
**WHITE**

CLARA-6	CLARA-12	CLARA-15
016-016-0006	016-016-0012	016-016-0015

Power	: 6 W	12 W	15 W
Luminous Flux	: 600 lm	1200 lm	1500 lm
Cutting Diameter (mm)	: Ø73	Ø125	Ø165
Sizes (mm)	: A: 96 B: 40	A: 160 B: 40	A: 200 B: 40

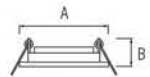
**AMANDA**

- 220-240V / 50-60Hz
- Срок службы 30 000 Часов
- 3000K/6400K

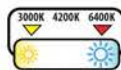
**WHITE****MAT CHROME**

AMANDA-6	AMANDA-10	AMANDA-15	AMANDA-25
016-017-0006	016-017-0010	016-017-0015	016-017-0025

Power	: 6 W	10 W	15 W	25 W
Luminous Flux	: 600 lm	1000 lm	1500 lm	2500 lm
Cutting Diameter (mm)	: Ø110	Ø137	Ø166	Ø200
Sizes (mm)	: A: 120 B: 42	A: 150 B: 50	A: 180 B: 60	A: 219 B: 70

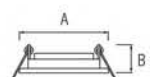

**HOROZ ELECTRIC**

LED светильники, встраиваемые

**LUCIA**

- 85-265V / 50-60Hz
- Срок службы 30 000 Часов
- 6400K

WHITE

**NEW  
PRODUCT****COB  
LED**

	LUCIA-10	LUCIA-15	LUCIA-20	LUCIA-25	LUCIA-30	LUCIA-35	LUCIA-40
	016-046-0010	016-046-0015	016-046-0020	016-046-0025	016-046-0030	016-046-0035	016-046-0040
Power :	10 W	15 W	20 W	25 W	30 W	35 W	40 W
Luminous Flux:	1000 lm	1500 lm	2000 lm	2500 lm	3000 lm	3500 lm	4000 lm
Cutting Diameter:	Ø75	Ø85	Ø95	Ø120	Ø145	Ø165	Ø200
Sizes (mm) :	A: 37 B: 86	A: 44,5 B: 101	A: 53 B: 116	A: 62,6 B: 140	A: 73 B: 163	A: 84 B: 190	A: 99 B: 217

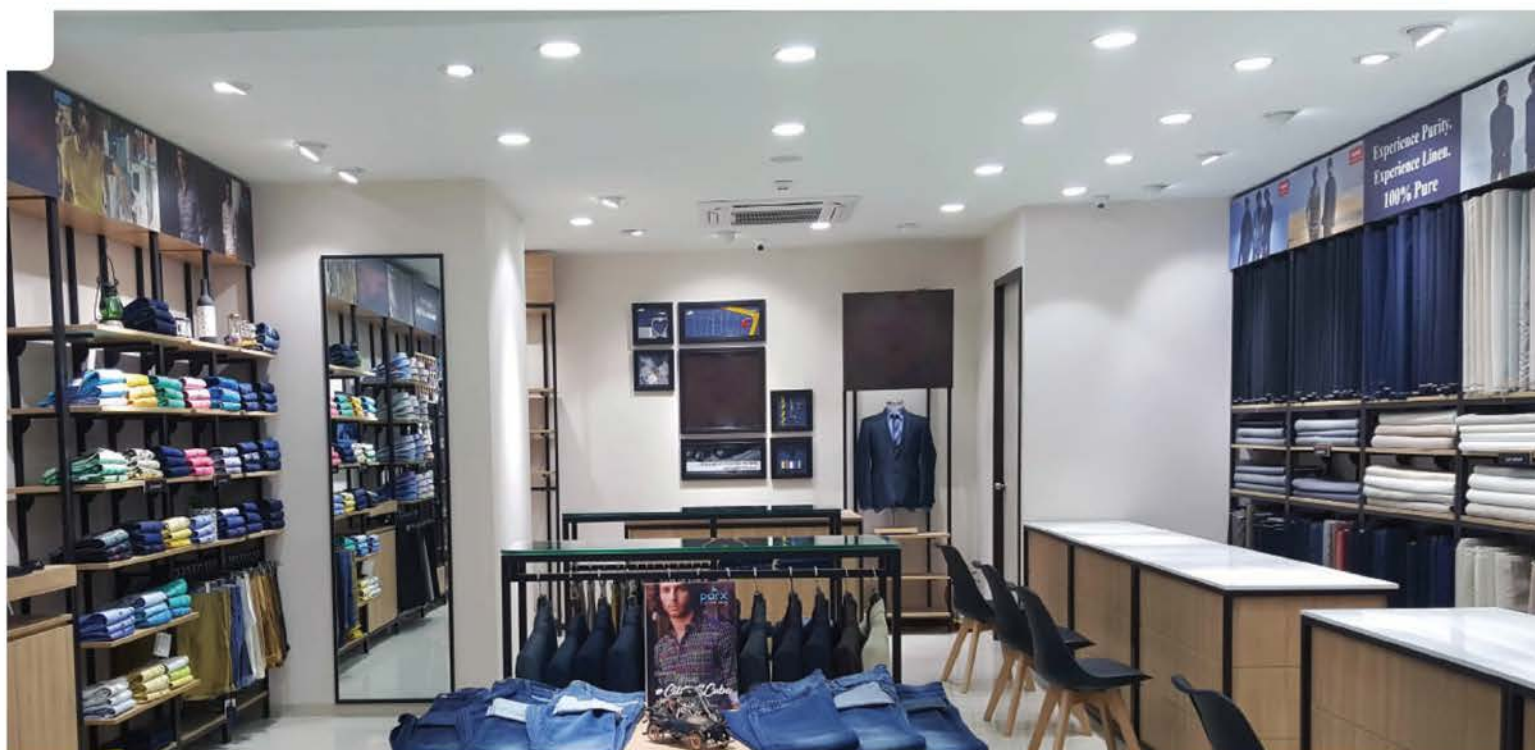
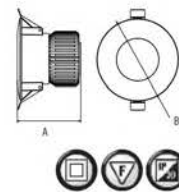



**HOROZ ELECTRIC**

LED светильники, встраиваемые

**VANESSA**

- 85-265V / 50-60Hz
- Срок службы 30 000 Часов
- 6400K

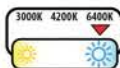

WHITE

**NEW  
PRODUCT**

	VANESSA-5	VANESSA-10	VANESSA-15	VANESSA-20	VANESSA-30
	016-044-0005	016-044-0010	016-044-0015	016-044-0020	016-044-0030
Power	: 6 W	: 10 W	: 15 W	: 20 W	: 30 W
Luminous Flux	: 600lm	: 1000 lm	: 1500 lm	: 2000 lm	: 3000lm
Cutting Diameter (mm)	: Ø75	: Ø95	: Ø150	: Ø170	: Ø205
Sizes (mm)	: A: 43 B: 90	: A: 43 B: 120	: A: 43 B: 170	: A: 45 B: 195	: A: 45 B: 225

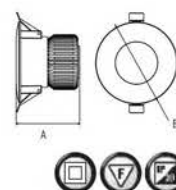
**ALEXA**

- 160-265V / 50-60Hz
- Срок службы 30 000 Часов
- 6400K

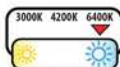

WHITE

**NEW  
PRODUCT**

	ALEXA-8	ALEXA-12	ALEXA-20	ALEXA-24	ALEXA-30
	016-047-0008	016-047-0012	016-047-0020	016-047-0024	016-047-0030
Power	: 8 W	: 12 W	: 20 W	: 24 W	: 30 W
Luminous Flux	: 960 lm	: 1440 lm	: 2400 lm	: 2880 lm	: 3600 lm
Cutting Diameter (mm)	: Ø75	: Ø95	: Ø115	: Ø145	: Ø190
Sizes (mm)	: A: 32 B: 98	: A: 32 B: 120	: A: 32 B: 145	: A: 32 B: 180	: A: 32 B: 230

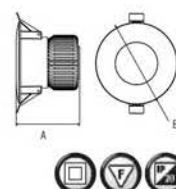



**HORIZ ELECTRIC**

LED светильники, накладные

**SANDRA**

- 185-264V / 50-60Hz
- Average Life: 30.000 Hrs
- 4200K

**SANDRA-XL**

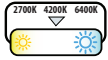

WHITE

BLACK



	SANDRA-5	SANDRA-5/XL	SANDRA-10	SANDRA-10/XL	SANDRA-15	SANDRA-15/XL
	016-043-0005	016-043-1005	016-043-0010	016-043-1010	016-043-0015	016-043-1015
Power :	5 W	5 W	10 W	10 W	15 W	15 W
Luminous Flux :	350 lm	350 lm	700 lm	700 lm	1050 lm	1050 lm
Sizes (mm) :	A:105 B:75	A:105 B:162	A:140 B:75	A:140 B:162	A:180 B:75	A:180 B:162

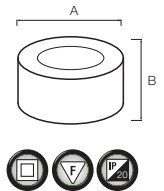

**SANDRA-SQ**

- 185-264V / 50-60Hz
- Average Life: 30.000 Hrs
- 4200K

**SANDRA-SQ/XL**

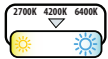

WHITE

BLACK



	SANDRA-SQ10	SANDRA-SQ10/XL	SANDRA-SQ15	SANDRA-SQ15/XL
	016-045-0010	016-045-1010	016-045-0015	016-045-1015
Power :	10 W	10 W	15 W	15 W
Luminous Flux :	700 lm	700 lm	1050 lm	1050 lm
Sizes (mm) :	A:136 B:120	A:136 B:200	A:182 B:120	A:182 B:200

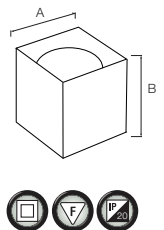

**FREZYA**

- 220-240V / 50-60Hz
- Max. 50W



WHITE

BLACK



FREZYA-R

015-026-0050

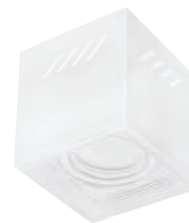

FREZYA-S

015-027-0050



LED Светильники  
накладные



**CAROLINE**

- Average Life: 30.000 Hrs
- 3000K/4200K/6000K

WHITE

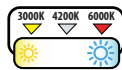

	CAROLINE-12	CAROLINE-18	CAROLINE-28	CAROLINE-32	CAROLINE-40	CAROLINE-48
	016-025-0012	016-025-0018	016-025-0028	016-025-0032	016-025-0040	016-025-0048
Power :	12 W	18 W	28 W	32 W	40 W	48 W
Luminous Flux :	840 lm	1300 lm	1960 lm	2240 lm	2800 lm	3360 lm
Volt :	165-260V/50-60Hz	165-260V/50-60Hz	165-260V/50-60Hz	185-264V/50-60Hz	185-264V/50-60Hz	185-264V/50-60Hz
Sizes (mm) :	A:160 B:28	A:210 B:28	A:287 B:28	A:400 B:40	A:500 B:40	A:600 B:40

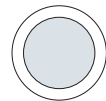
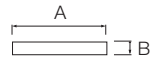

**ARINA**

- 165-260V / 50-60Hz
- Average Life: 30.000 Hrs
- 3000K/4200K/6400K

WHITE

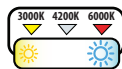

	ARINA-12	ARINA-18	ARINA-28
	016-026-0012	016-026-0018	016-026-0028
Power :	12 W	18 W	28 W
Luminous Flux :	840 lm	1300 lm	1960 lm
Sizes (mm) :	A:159.5 B:28	A:211 B:28	A:283 B:28

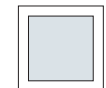
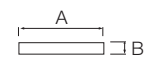

**HOROZ ELECTRIC**

LED панели, встраиваемые

**SLIM**

- 220-240V / 50-60Hz
- Срок службы 30 000 Часов
- 2700K / 4200K / 6400K

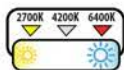

	SLIM-3	SLIM-6	SLIM-9	SLIM-12	SLIM-15	SLIM-18	SLIM-24
	056-003-0003	056-003-0006	056-003-0009	056-003-0012	056-003-0015	056-003-0018	056-003-0024
Power :	3 W	6 W	9 W	12 W	15 W	18 W	24 W
Luminous Flux:	300 lm	600 lm	900 lm	1200 lm	1500 lm	1800 lm	2400 lm
Cutting Diameter :	Ø70	Ø108	Ø132	Ø155	Ø176	Ø215	Ø279
Sizes (mm) :	A:14 B:83	A:14 B:118.5	A:14 B:146	A:14 B:168	A:17 B:190	A:14 B:221	A:14.5 B:297

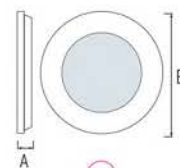
**HOROZ ELECTRIC**LED панели,  
встраиваемые**SLIM/Sq**

- 220-240V / 50-60Hz
- Срок службы 30 000 Часов
- 2700K / 4200K / 6400K

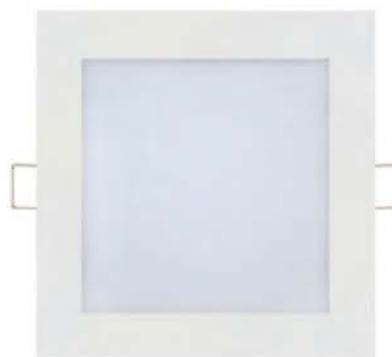
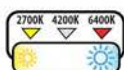

	SLIM / Sq-3	SLIM / Sq-6	SLIM / Sq-9	SLIM / Sq-12	SLIM / Sq-15	SLIM / Sq-18	SLIM / Sq-24
	056-005-0003	056-005-0006	056-005-0009	056-005-0012	056-005-0015	056-005-0018	056-005-0024
Power :	3 W	6 W	9 W	12 W	15 W	18 W	24 W
Luminous Flux:	300 lm	600 lm	900 lm	1200 lm	1500 lm	1800 lm	2400 lm
Cutting Size (mm) :	76x76	105x105	135x135	156x156	178x178	207x207	282x282
Sizes (mm) :	A:16 B:89	A:18 B:113.5	A:16 B:146	A:18 B:163	A:15 B:194.5	A:18 B:219.5	A:17 B:296

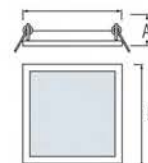



**HOROSZ ELECTRIC**

LED панели, встраиваемые

**PLAZMA-45**

- 175-265V / 50-60Hz
- Average Life: 20.000 Hrs
- 3375 lm
- 4200K / 6400K

056 010 0045

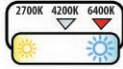

Задняя подсветка  
панели



Внутри продукта

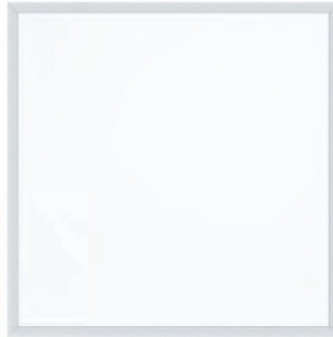

WHITE

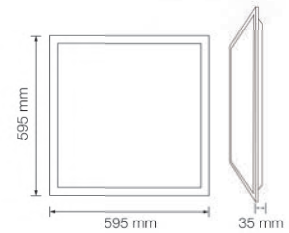

**HOROSZ ELECTRIC**

LED панели  
встраиваемые



**EUROPA-80**

- 175-265V / 50-60Hz
- Average Life: 20.000 Hrs
- 5575 lm
- 4200K / 6400K

056 009 0080

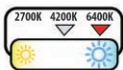

Задняя подсветка  
панели



Внутри продукта



SILVER

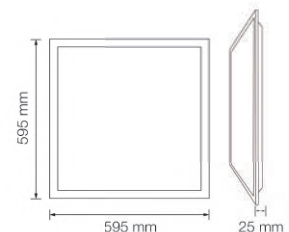

**HOROSZ ELECTRIC**

LED панели, универсальные

**GALAKSI-45**

056 002 0045

**WHITE**

- 220-240V / 50-60Hz
- 45W, 3150 lm
- 4200K / 6400K
- Срок службы 25 000 Часов

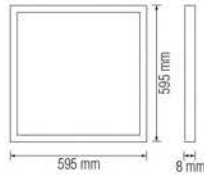
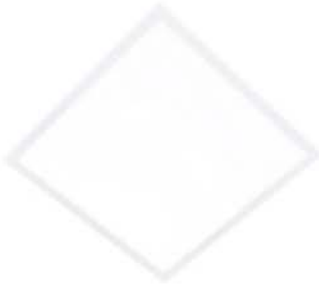
**STAR-50**

056 001 0050

**SILVER**

- 220-240V / 50-60Hz
- 50W, 4200 lm
- 4200K / 6400K
- Срок службы 25 000 Часов

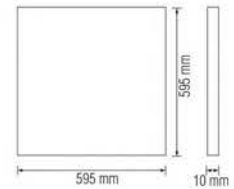
**MOON**

- 220-240V / 50-60Hz
- Срок службы 25 000 Часов
- 4200K / 6400K

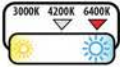
**MOON-32****MOON-40**

056-007-0032

056-007-0040

Power	:	<b>32 W</b>	<b>40 W</b>
Luminous Flux	:	2240 lm	2800 lm
Sizes (mm)	:	A: 400 B: 400 C: 8	A: 500 B: 500 C: 8

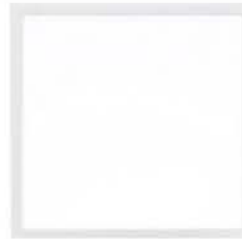
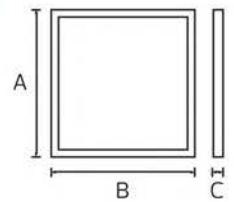
**WHITE****ZODIAC**

- 220-240V / 50-60Hz
- Срок службы 25 000 Часов
- 4200K / 6400K

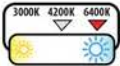
**ZODIAC-24****ZODIAC-36**

056-006-0024

056-006-0036

Power	:	<b>24 W</b>	<b>36 W</b>
Luminous Flux	:	1680 lm	2520 lm
Sizes (mm)	:	A: 295 B: 595 C: 8	A: 295 B: 1195 C: 8

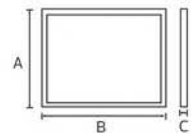
**WHITE****FRAME****WHITE****DRY KIT**

111 001 0001

- Крепёжная рамка
- Для LED панелей

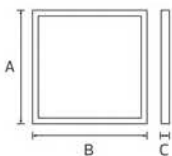
**FRAME-3060****FRAME-30120****FRAME-4040****FRAME-5050****FRAME-6060**

111-002-0001

111-002-0002

111-002-0003

111-002-0004

111-002-0005

Sizes (mm):	A: 600 B: 300 C: 45	A: 1200 B: 300 C: 45	A: 400 B: 400 C: 45	A: 500 B: 500 C: 45	A: 600 B: 600 C: 45
-------------	---------------------	----------------------	---------------------	---------------------	---------------------





**HOROZ ELECTRIC**

LED Системы трекового освещения

**ARIZONA**

- 100-240V / 50-60Hz
- Average Life: 30.000 Hrs
- 4200K

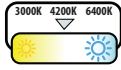

WHITE

BLACK



ARIZONA-5	ARIZONA-10
018-027-0005	018-027-0010

Power	: 5 W	10 W
Luminous Flux	: 380 lm	650 lm
Beam Angle	: 52°	60°

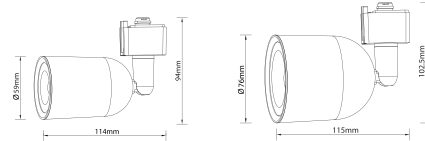

LED Системы трекового освещения



**VARNA**

- 175-265V / 50-60Hz
- Average Life: 30.000 Hrs
- 4200K
- Beam Angle: 24°

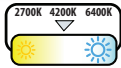

WHITE

BLACK



VARNA-20	VARNA-30	VARNA-36
018-026-0020	018-026-0030	018-026-0036

Power	: 20 W	30 W	36 W
Luminous Flux	: 1600 lm	2400 lm	2880 lm
Sizes (mm)	: A: 72 B: 125 C: 160	A: 81 B: 130 C: 170	A: 91 B: 140 C: 180

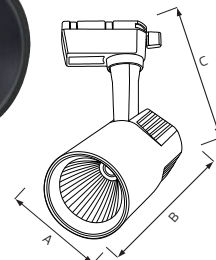

**HOROZ ELECTRIC**

## LED системы трекового освещения

Z O O M A B L E

**MONACO**

- 100-240V / 50-60Hz
- Срок службы 40 000 Часов
- 4200K
- Угол освещения: 15°-60°

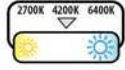
**NEW PRODUCT**

WHITE

BLACK



MONACO-15	MONACO-30
018-019-0015	018-019-0030

Power	: 15 W	30 W
Luminous Flux	: 1125 lm	2250 lm
Sizes (mm)	: A: 150 B: 130 C: 140 D: 47 E: 59	A: 190 B: 170 C: 165 D: 64 E: 85

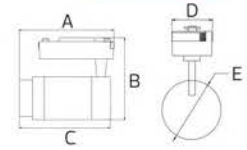
**HOROZ ELECTRIC**

## LED системы трекового освещения

**LYON**

- 100-240V / 50-60Hz
- Срок службы 40 000 Часов
- 4200K
- Угол освещения: 24°

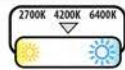
**NEW PRODUCT**

WHITE

BLACK



LYON-10	LYON-18	LYON-24
018-020-0010	018-020-0018	018-020-0024

Power	: 10 W	18 W	24 W
Luminous Flux	: 650 lm	1170 lm	1560 lm
Sizes (mm)	: A: 81 B: 140 C: 102 D: 37 E: 68	A: 170 B: 162 C: 110 D: 61 E: 84	A: 200 B: 190 C: 140 D: 66 E: 89

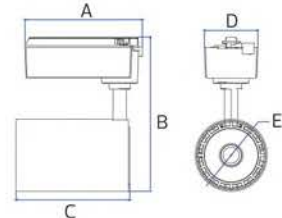
**BERN**

018 017 0030

**NEW PRODUCT**WHITE  
BLACK

- 180-240V / 50-60Hz
- Срок службы 30 000 Часов
- 2000 lm
- 4200K
- Угол освещения: 21°

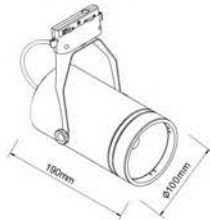
**DUBLIN**

018 018 0035

**NEW PRODUCT**WHITE  
BLACK

- 180-240V / 50-60Hz
- Срок службы 30 000 Часов
- 3400 lm
- 4200K
- Срок службы 30 000 Часов

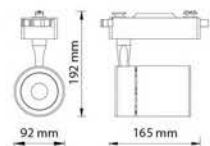





**HOROSZ ELECTRIC**

LED системы трекового освещения

Z O O M A B L E

**PORTO**

018 013 0007

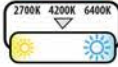

WHITE

BLACK

SILVER

- 100-240V / 50-60Hz
- Срок службы 40 000 Часов
- 525 lm
- 4200K
- Угол освещения: 18°-70°



**OSLO**

018 012 0010



WHITE

BLACK

SILVER

- 100-240V / 50-60Hz
- Срок службы 40 000 Часов
- 900 lm
- 4200K
- Угол освещения: 21°

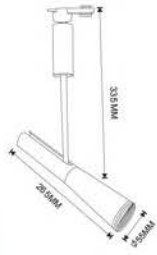

**ROMA**

018 002 0023



WHITE

BLACK

SILVER

- 220-240V / 50-60Hz
- Срок службы 40 000 Часов
- 1315 lm
- 4200K
- Угол освещения: 60°

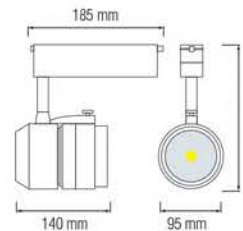

**ZAGREB**

018 009 0035



WHITE

BLACK

SILVER

- 100-240V / 50-60Hz
- Срок службы 40 000 Часов
- 2078 lm
- 4200K
- Угол освещения: 20°

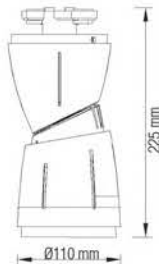

**HOROSZ ELECTRIC**

LED системы трекового освещения

**PARIS**

- 220-240V / 50-60Hz
- Срок службы 40 000 Часов
- 4200K
- Угол освещения: 24°

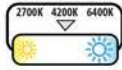

WHITE

BLACK

SILVER

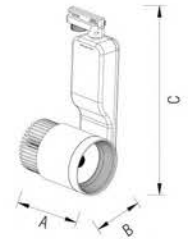

PARIS-23

PARIS-33

018-007-0023

018-007-0033

Power	:	<b>23 W</b>	<b>33 W</b>
Luminous Flux	:	1550 lm	2256 lm
Sizes (mm)	:	A: 110 B: 110 C: 280	A: 128 B: 124 C: 290

**ZURIH**

- 220-240V / 50-60Hz
- Срок службы 40 000 Часов
- 4200K
- Угол освещения: 24°

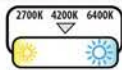

WHITE

BLACK

SILVER

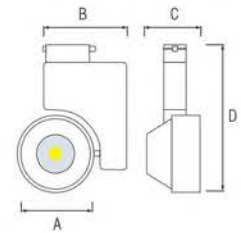

ZURIH-23

ZURIH-40

018-001-0023

018-001-0040

Power	:	<b>23 W</b>	<b>40 W</b>
Luminous Flux	:	1511 lm	2643 lm
Sizes (mm)	:	A: 110 B: 120 C: 65 D: 210	A: 120 B: 156 C: 68 D: 223

**PRAG**

- 220-240V / 50-60Hz
- Срок службы 40 000 Часов
- 4200K



WHITE

BLACK

SILVER

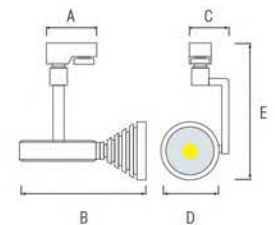

PRAG-7

PRAG-12

018-003-0007

018-003-0012

Power	:	<b>7 W</b>	<b>12 W</b>
Luminous Flux	:	405 lm	852 lm
Beam Angle	:	37°	32°
Sizes (mm)	:	A: 65 B: 170 C: 88 D: 90 E: 265	A: 65 B: 175 C: 85 D: 110 E: 278



**HOROSZ ELECTRIC**

LED системы трекового освещения

**TORINO**

- 220-240V / 50-60Hz
- Срок службы 40 000 Часов
- 4200K
- Угол освещения: 24°

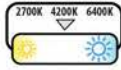

- WHITE
- BLACK
- SILVER

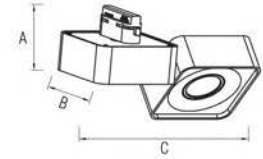

TORINO-23	TORINO-40
018-004-0023	018-004-0040

Power	: 23 W	40 W
Luminous Flux	: 1560 lm	2337 lm
Sizes (mm)	: A: 89 B: 120 C: 241	A: 112.5 B: 120 C: 241

**MADRID**

- 220-240V / 50-60Hz
- Срок службы 40 000 Часов
- 4200K
- Угол освещения: 24°

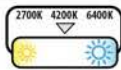

- WHITE
- BLACK
- SILVER

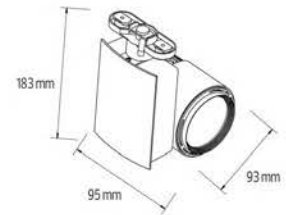

MADRID-23	MADRID-40
018-005-0023	018-005-0040

Power	: 23 W	40 W
Luminous Flux	: 1779 lm	2988 lm

**VENEDIK**

- 220-240V / 50-60Hz
- Срок службы 40 000 Часов
- 4200K
- Угол освещения: 24°

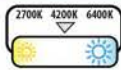

- WHITE
- BLACK
- SILVER

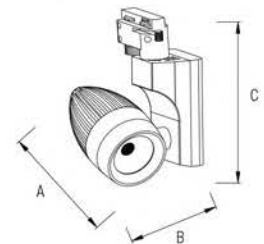

VENEDIK-23	VENEDIK-33
018-006-0023	018-006-0033

Power	: 23 W	33 W
Luminous Flux	: 1947 lm	2142 lm
Sizes (mm)	: A: 120 B: 140 C: 175	A: 175 B: 140 C: 185





**HOROSZ ELECTRIC**

## LED системы трекового освещения

### MILANO

- 220-240V / 50-60Hz
- Срок службы 40 000 Часов
- 4200K

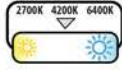

WHITE

BLACK

SILVER



MILANO-5	MILANO-8	MILANO-13
018-008-0005	018-008-0008	018-008-0013

Power	: 5 W	8 W	13 W
Luminous Flux	: 334 lm	600 lm	987 lm
Beam Angle	: 55°	53°	73°
Sizes (mm)	: A: 40 B: 70 C: 128	A: 48 B: 95 C: 132	A: 60 B: 108 C: 145

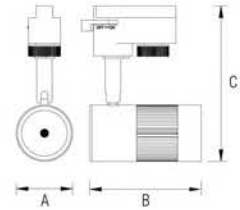

**HOROSZ ELECTRIC**

## LED системы трекового освещения



### BEYRUT

017 001 0005



WHITE  
BLACK

- 220-240V / 50-60Hz
- Срок службы 40 000 Часов
- 320 lm
- 4200K
- Угол освещения: 60°

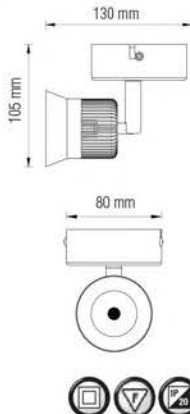

### TOKYO

017 002 0008



WHITE  
BLACK

- 100-240V / 50-60Hz
- Срок службы 40 000 Часов
- 500 lm
- 4200K
- Угол освещения: 53°

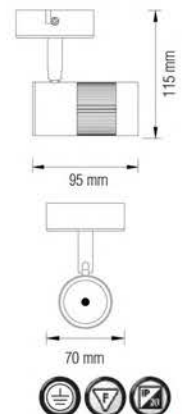

**BASEL**

115 003 0001



WHITE

BLACK

- 220-240V / 50-60Hz
- Max. 50W
- Bulb not included

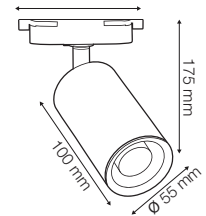

**DAKAR**

115 001 0001

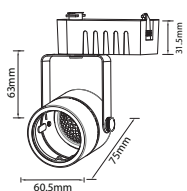

**RABAT**

115 002 0001

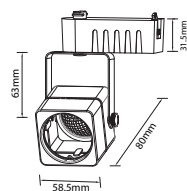

WHITE

BLACK

- 220-240V / 50-60Hz
- Max. 50W
- Bulb not included





**HOGOZ ELECTRIC**

## LED системы трекового освещения

### СОЕДИНИТЕЛИ

- Однофазный
- 220-240V / 50-60Hz AC
- Max. 16A

WHITE

BLACK

SILVER

096 001 0001

Прямой коннектор



Угловой коннектор



096 002 0002

### ВСТРАИВАЕМЫЙ ШИНОПРОВОД

098 001 0001

WHITE

BLACK

SILVER

- 220-240V / 50-60Hz
- Max. 16A

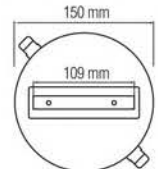

125



### ШИНОПРОВОД

1m, 2m, 3m

WHITE

BLACK

SILVER

- 220-240V / 50-60Hz
- Max. 16A

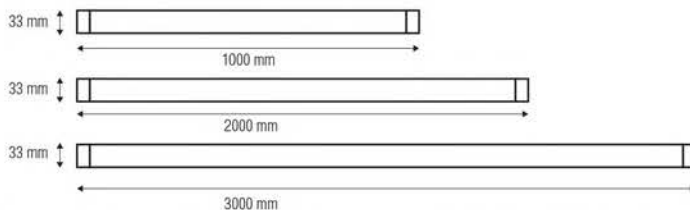

1m. 097 001 0001

2m. 097 001 0002

3m. 097 001 0003



**HOROZ ELECTRIC**

LED Подвесные светильники

**INNOVO-40**

019 033 0040

30 mm width

**INNOVA-40**

019 034 0040

50 mm width

**BLACK**

**WHITE**

- 170-265V / 50-60Hz
- Average Life: 70.000 Hrs
- 3200 lm
- 4000K

**NEW PRODUCT**

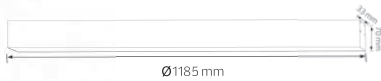

Ø1185 mm

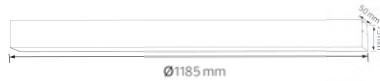

Ø1185 mm



**HOROZ ELECTRIC**

LED Подвесные  
светильники





**HOROZ ELECTRIC**

LED Подвесные светильники

**PRIME-45**

019 029 0045



**NEW  
PRODUCT**



**CHROME**

- 110-240V / 50-60Hz
- Срок службы 30 000 Часов
- 3500 lm
- 4000K

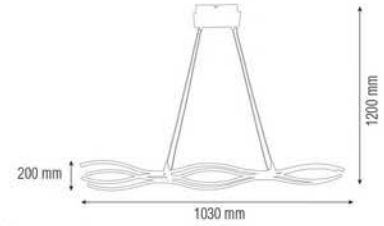

**HOROZ ELECTRIC**

LED Подвесные  
светильники



**OPTIMA-6**

019 030 0006

**NEW  
PRODUCT**



**OPTIMA-12**

019 030 0012



**OPTIMA-18**

019 030 0018



**CHROME**

- 110-240V / 50-60Hz
- Срок службы 30 000 Часов
- 450 lm / 900 lm / 1350 lm
- 4000K

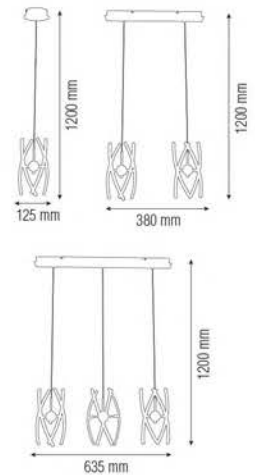



**CALIBUR-24**

019 031 0024

**CHROME**

- 110-240V / 50-60Hz
- Срок службы 30 000 Часов
- 1800 lm
- 4000K

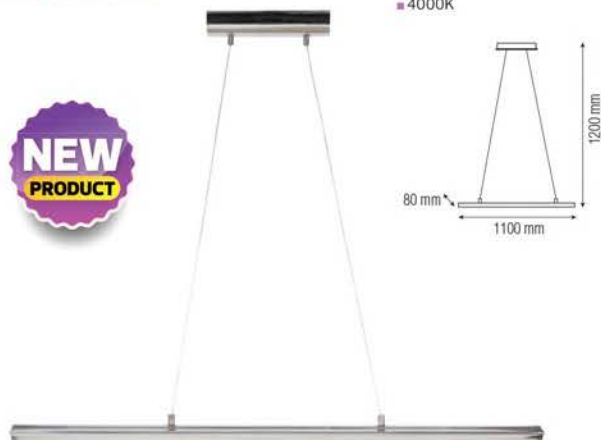
**NEW  
PRODUCT**

**24W SMD LED**

**CAMEL-40**

019 032 0040

**CHROME**

- 110-240V / 50-60Hz
- Срок службы 30 000 Часов
- 3000 lm
- 4000K

**NEW  
PRODUCT**

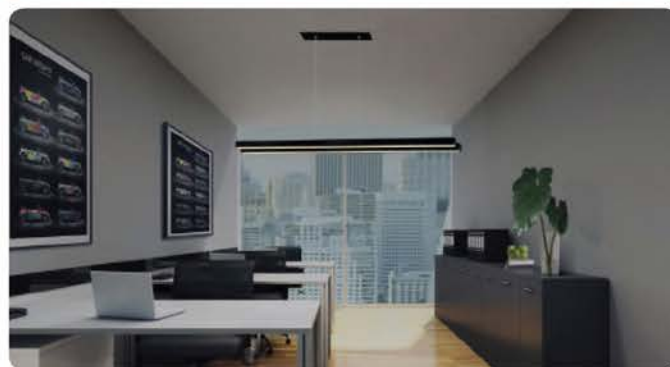
**40W SMD LED**

**COSTA-35**

019 015 0035

**BLACK**
**WHITE**

- 220-240V / 50-60Hz
- Срок службы 50 000 Часов
- 2000 lm
- 4000K

**35W SMD LED**

**MATRIX-35**

019 013 0035

**BLACK**
**WHITE**

- 220-240V / 50-60Hz
- Срок службы 50 000 Часов
- 2000 lm
- 4000K

**35W SMD LED**

**PHOENIX**

019 020 0038

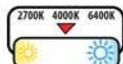

**CHROME**

**RED COPPER**

- 110-240V / 50-60Hz
- Срок службы 30 000 Часов
- 2623lm
- 4000K



**ELECTRA**

019 021 0038

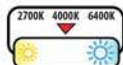

**CHROME**

**RED COPPER**

- 110-240V / 50-60Hz
- Срок службы 30 000 Часов
- 2548lm
- 4000K



**OLYMPIC**

**BLACK**

019 035 0045



- 180-240V / 50-60Hz
- Average Life: 30.000Hrs
- 2025 lm
- 4000K

**NEW PRODUCT**



**GENESIS**

**CHROME**

019 036 0100



- 180-240V / 50-60Hz
- Average Life: 30.000 Hrs
- 4500 lm
- 4000K

**NEW PRODUCT**



**CRATER**

**CHROME**

019 037 0020



- 180-240V / 50-60Hz
- Average Life: 30.000Hrs
- 900 lm
- 4000K

**NEW PRODUCT**





**HOROZ ELECTRIC**

LED люстры

**AVATAR**

019 039 0033

**CHROME**

- 180-260V / 50-60Hz
- Average Life: 30.000 Hrs
- 2310 lm
- 4000K

**NEW PRODUCT**

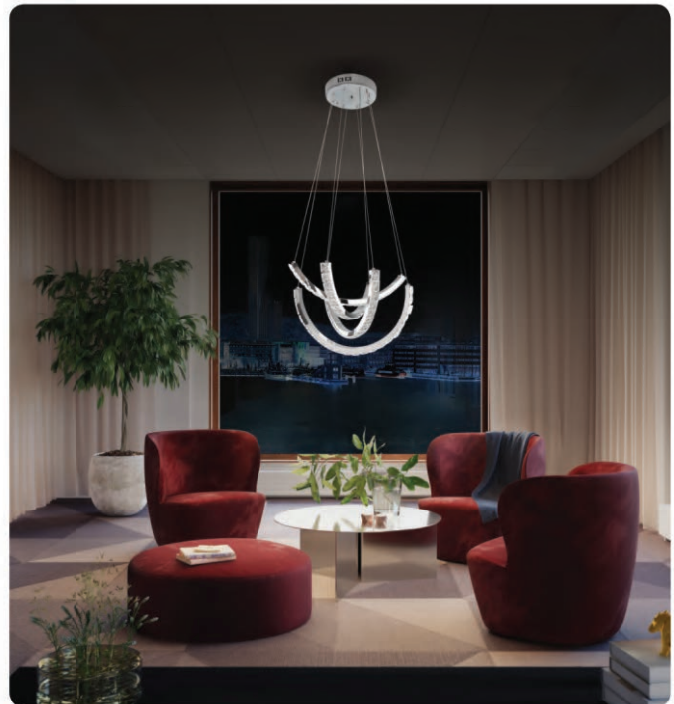
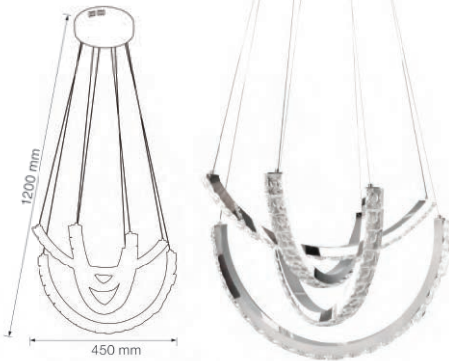

**AVIATOR**

- 180-260V / 50-60Hz
- Average Life: 30.000 Hrs
- 4000K

**CHROME**

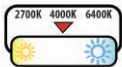

**NEW PRODUCT**



	AVIATOR-24	AVIATOR-40	AVIATOR-56
	019-038-0024	019-038-0040	019-038-0056

Power	: 24 W	40 W	56 W
Luminous Flux	: 1680 lm	2800 lm	3920 lm

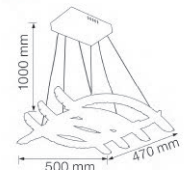
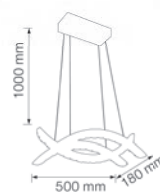



**HORUZ ELECTRIC**

LED люстры

**VOYAGER**

- 180-260V / 50-60Hz
- Average Life: 30.000 Hrs
- 4000K

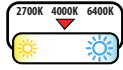

CHROME

**NEW PRODUCT**

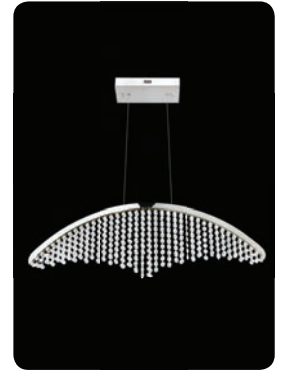

VOYAGER-12	VOYAGER-18	VOYAGER-24
019-041-0012	019-041-0018	019-041-0024

Power	: 12 W	18 W	24 W
Luminous Flux	: 840 lm	1260 lm	1680 lm
Length (mm)	: L: 410	L: 565	L: 815

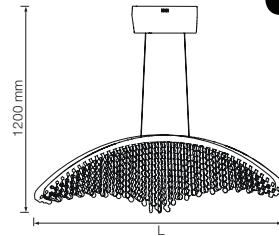

**ASTORIA**

- 180-260V / 50-60Hz
- Average Life: 30.000 Hrs
- 4000K

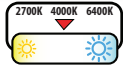

CHROME

**NEW PRODUCT**



ASTORIA-19	ASTORIA-25	ASTORIA-32	ASTORIA-38
019-040-0019	019-040-0025	019-040-0032	019-040-0038

Power	: 19 W	25 W	32 W	38 W
Luminous Flux	: 1330 lm	1750 lm	2240 lm	2660 lm
Diameter (mm)	: Ø: 300	Ø: 400	Ø: 500	Ø: 600

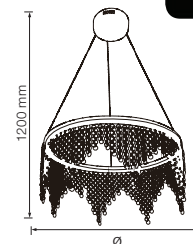

**ORIENT**

019 016 0016

**CHROME**

- 110-240V / 50-60Hz
- Срок службы 30 000 Часов
- 1211lm
- 4000K

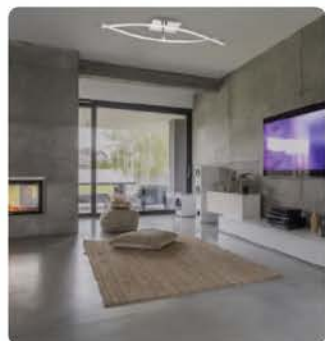
**ORION**

019 017 0030

**CHROME**

- 110-240V / 50-60Hz
- Срок службы 30 000 Часов
- 2059lm
- 4000K

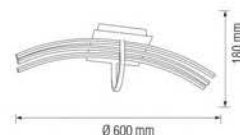
**AVALON**

019 018 0035

**CHROME**

- 110-240V / 50-60Hz
- Срок службы 30 000 Часов
- 2100lm
- 4000K

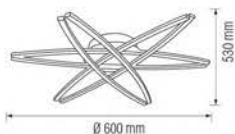
**GLORY**

019 019 0045

**CHROME**

- 110-240V / 50-60Hz
- Срок службы 30 000 Часов
- 3964lm
- 4000K



## NEBULA

019 026 0040

CHROME

- 180-260V / 50-60Hz
- Срок службы 30 000 Часов
- 1200 lm
- 4000K

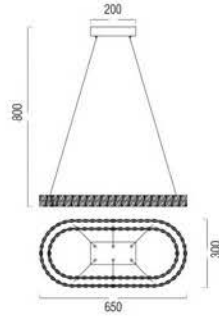

## POLARIS

019 024 0046

CHROME

- 180-260V / 50-60Hz
- Срок службы 30 000 Часов
- 1380 lm
- 4000K

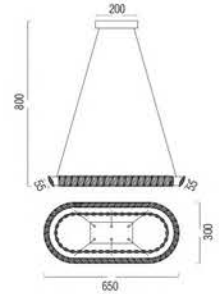
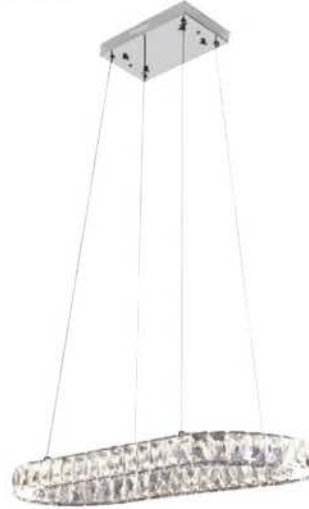

## TORNADO

- 180-260V / 50-60Hz
- Срок службы 30 000 Часов
- 4000K

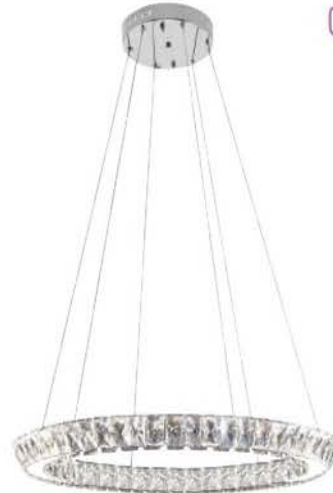

CHROME

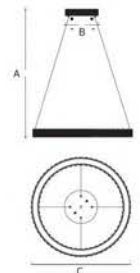

TORNADO-30      TORNADO-40

019-025-0030

019-025-0040

Power	:	30 W	40 W
Luminous Flux	:	900 lm	1200 lm
Sizes (mm)	:	A: 800 B: 150 C: 400	A: 800 B: 200 C: 600



**NOGOZ ELECTRIC**

LED Люстры

**ETERNITY**

- 180-260V / 50-60Hz
- Срок службы 30 000 Часов
- 4000K

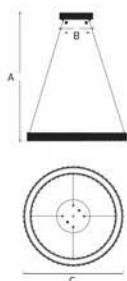
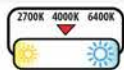
**ETERNITY-30****ETERNITY-40**

019-022-0030

019-022-0040

Power	:	<b>30 W</b>	<b>40 W</b>
Luminous Flux	:	900 lm	1200 lm
Sizes (mm)	:	A: 800 B: 150 C: 400	A: 800 B: 200 C: 600

**CHROME****QUASAR**

- 180-260V / 50-60Hz
- Срок службы 30 000 Часов
- 4000K

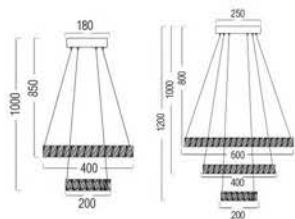
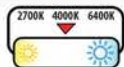
**QUASAR-42****QUASAR-90**

019-023-0042

019-023-0090

Power	:	<b>42 W</b>	<b>90 W</b>
Luminous Flux	:	1260 lm	2700 lm

**CHROME**



**HOZ ELECTRIC****LED Люстры****NIRVANA**

- 180-260V / 50-60Hz
- Срок службы 30 000 Часов
- 4000K

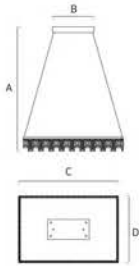
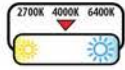
**CHROME**

NIRVANA-24	NIRVANA-32	NIRVANA-40
019-027-0024	019-027-0032	019-027-0040

Power	: 24 W	32 W	40 W
Luminous Flux	: 720 lm	960 lm	1200 lm
Sizes (mm)	: A: 800 B: 200 C: 400 D: 200	A: 1000 B: 200 C: 500 D: 300	A: 1000 B: 250 C: 600 D: 400

**PANDORA**

- 180-260V / 50-60Hz
- Срок службы 30 000 Часов
- 4000K

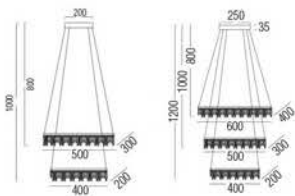
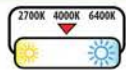
**CHROME**

PANDORA-72	PANDORA-96
019-028-0072	019-028-0096

Power	: 72 W	96 W
Luminous Flux	: 2160 lm	2880 lm



**DELUXE**

- 220-240V / 50-60Hz
- Срок службы 50 000 Часов
- 4000K

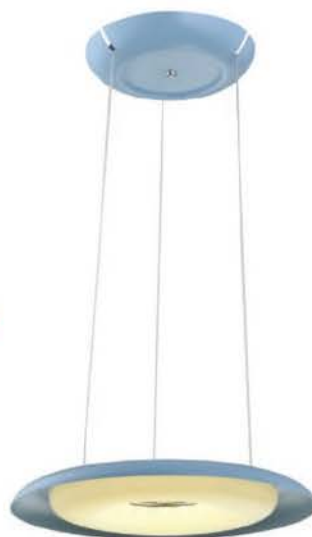
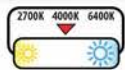

- BLACK
- WHITE
- RED
- BLUE



DELUXE-35	DELUXE-70
019-012-0035	019-012-0070

Power	: 35 W	70 W
Luminous Flux	: 2000 lm	3900 lm
Sizes (mm)	: A: 1200 B: 250 C: 420	A: 1200 B: 250 C: 580

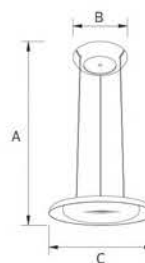

**CONCEPT**

- 220-240V / 50-60Hz
- Срок службы 50 000 Часов

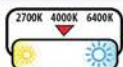

- ROSE
- CHROME
- WHITE



CONCEPT-35	CONCEPT-41
019-010-0035	019-010-0041

Power	: 35 W	41 W
Luminous Flux	: 1000 lm	1500 lm
Sizes (mm)	: A: 200 B: 65 C:1200 D: 45 E: 461	A: 200 B: 65 C:1200 D: 45 E: 648

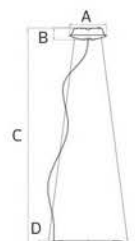

**ROYAL**

- 220-240V / 50-60Hz
- Срок службы 50 000 Часов
- 4000K

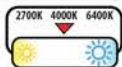

ROYAL-18	ROYAL-24
019-001-0018	019-001-0024

Power	: 18 W	24 W
Luminous Flux	: 1260 lm	1680 lm
Sizes (mm)	: A: 1000 B: 160 C: 454	A: 1000 B: 180 C: 604



WHITE

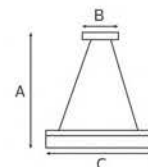

**CLASIS**

- 220-240V / 50-60Hz
- Срок службы 50 000 Часов
- 4000K



CLASIS-21	CLASIS-31	CLASIS-42
019-002-0021	019-002-0031	019-002-0042

Power	: 21 W	31 W	42 W
Luminous Flux	: 1470 lm	2170 lm	2940 lm
Sizes (mm)	: A: 1000 B: 160 C: 418	A: 1000 B: 180 C: 620	A: 1000 B: 180 C: 818



WHITE

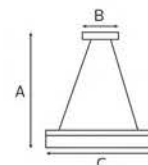



**HOROZ ELECTRIC**

LED Люстры

**MASTER**

- 220-240V / 50-60Hz
- Срок службы 50 000 Часов
- 4000K

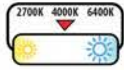

**WHITE**



MASTER-42

MASTER-75

019-003-0042

019-003-0075

Power	: 42 W	75 W
Luminous Flux	: 2940 lm	5250 lm
Sizes (mm)	: A: 1350 B: 504	A: 1500 B: 804

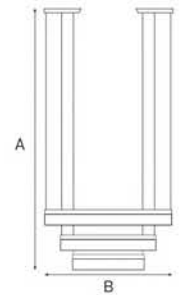

**EXCLUSIVE**

- 220-240V / 50-60Hz
- Срок службы 50 000 Часов
- 4000K

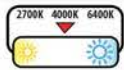

**WHITE**



EXCLUSIVE-24

EXCLUSIVE-40

019-004-0024

019-004-0040

Power	: 24 W	40 W
Luminous Flux	: 1680 lm	2800 lm

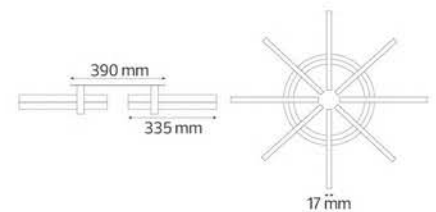

**HOROSZ ELECTRIC**

LED Люстры

**AVANGARD**

- 220-240V / 50-60Hz
- Срок службы 50 000 Часов
- 4000K

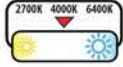

WHITE

BLACK



AVANGARD-24	AVANGARD-40
019-005-0024	019-005-0040

Power	: 24 W	40 W
Luminous Flux	: 1680 lm	2800 lm
Sizes (mm)	: A: 82.36 B: 42 C: 230 D: 515	A: 98 B: 50 C: 280 D: 550

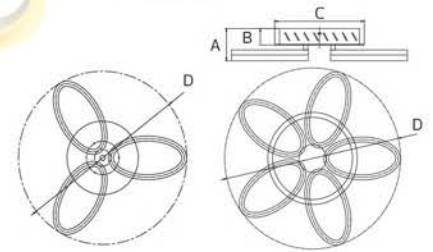
**ELEGANCE**

- 220-240V / 50-60Hz
- Срок службы 50 000 Часов
- 4000K

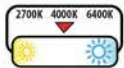

WHITE

BLACK



ELEGANCE-24	ELEGANCE-40
019-006-0024	019-006-0040

Power	: 24 W	40 W
Luminous Flux	: 1680 lm	2800 lm
Sizes (mm)	: A: 230 B: 42 C: 1319 D: 1200 E: 66.6 F: 515	A: 230 B: 42 C: 1319 D: 1200 E: 66.6 F: 550

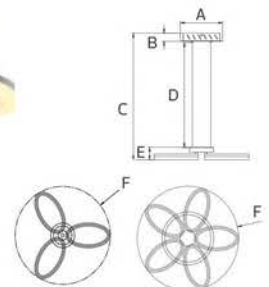

**TREND**

- 220-240V / 50-60Hz
- Срок службы 50 000 Часов
- 4000K

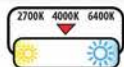

**BLACK**

**WHITE**



TREND-50	TREND-85
019-009-0050	019-009-0085

Power	: 50 W	85 W
Luminous Flux	: 800 lm	1400 lm
Sizes (mm)	: A: 190 B: 95 C: 550 D: 550	A: 270 B: 105 C: 790 D: 790

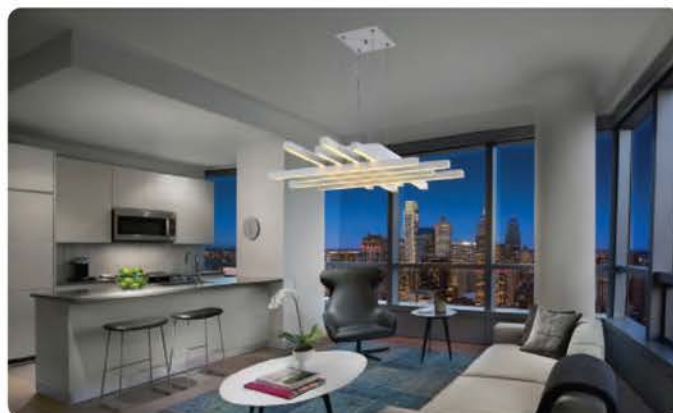
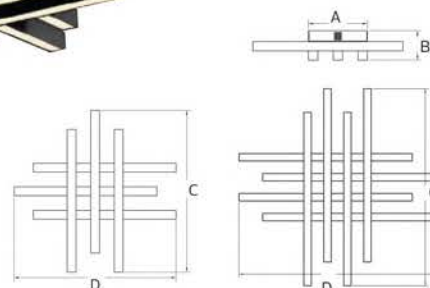

**ASFOR**

- 220-240V / 50-60Hz
- Срок службы 50 000 Часов
- 4000K

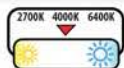

**BLACK**

**WHITE**



ASFOR-50	ASFOR-85
019-011-0050	019-011-0085

Power	: 50 W	85 W
Luminous Flux	: 800 lm	1400 lm
Sizes (mm)	: A: 160 B: 26 C: 1200 D: 95 E: 550 F: 550	A: 210 B: 26 C: 1200 D: 105 E: 790 F: 790

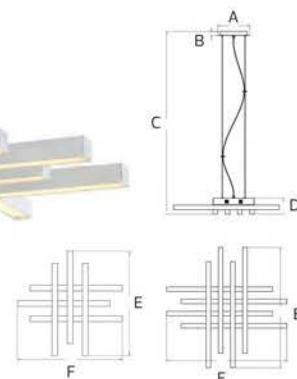



**HOROZ ELECTRIC**

LED Люстры / LED подвесы

**VISTA**

019 007 0024

WHITE

BLACK

RED

- 220-240V / 50-60Hz
- Срок службы 50 000 Часов
- 1500 lm
- 4000K

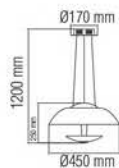

**FAVORI**

019 008 0062

CHROME

COPPER

BROWN

- 220-240V / 50-60Hz
- Срок службы 50 000 Часов
- 2500 lm
- 4000K

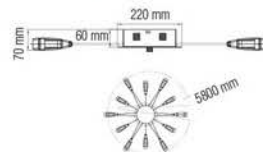
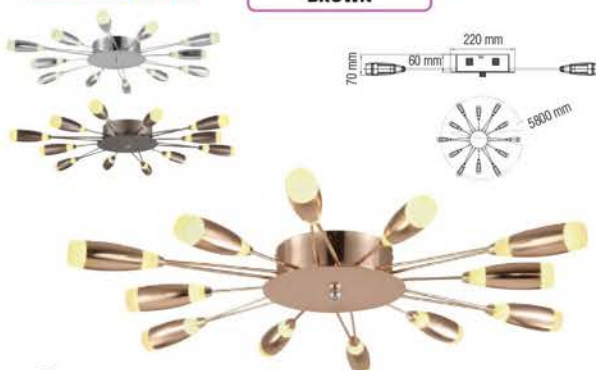

**HOROZ ELECTRIC**

LED Подвесы



**SEMBOL**

020 006 0012



BLACK

WHITE

RED

GREEN

YELLOW

BLUE

- 220-240V / 50-60Hz
- Срок службы 30 000 Часов
- 850 lm
- 4000K



**NOVA**

020 003 0006



BLACK

WHITE

PINK

PURPLE

ORANGE

BLUE

- 220-240V / 50-60Hz
- Срок службы 30 000 Часов
- 300 lm
- 4200K



**PRIZMA**

020 007 0006



BLACK

WHITE

PINK

PURPLE

ORANGE

BLUE

- 220-240V / 50-60Hz
- Срок службы 30 000 Часов
- 350 lm
- 4000K

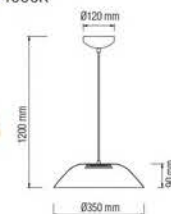



**HOROZ ELECTRIC**

Декоративные подвесы

**WEBER**

021 008 0001



RED COPPER

OLD BRONZE

GOLD

CHROME

PEARL BLACK

■ 250V~/4A  
■ Max. 60W



**GAUSS**

021 009 0001



RED COPPER

OLD BRONZE

GOLD

CHROME

PEARL BLACK

■ 250V~/4A  
■ Max. 60W



**HOROZ ELECTRIC**

Декоративные подвесы



**EDISON**

021 002 0001



RED COPPER

OLD BRONZE

GOLD

CHROME

PEARL BLACK

■ 250V~/4A  
■ Max. 60W



**VOLTA**

021 001 0001



BLACK

WHITE

BROWN

BLUE

RED

GREY

■ 250V~/4A  
■ Max. 60W



**TESLA**

021 003 0001



RED COPPER

OLD BRONZE

GOLD

CHROME

PEARL BLACK

■ 250V~/4A  
■ Max. 60W







**NOGOZ ELECTRIC**

Декоративные подвесы

**KEPLER**

021 011 0001

СКЛАДНОЙ



**BLACK**

- 250V~/4A
- Max. 60W

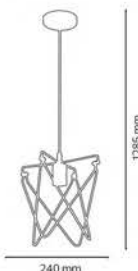

E27

**MAXWELL**

021 012 0001

СКЛАДНОЙ



**BLACK**

- 250V~/4A
- Max. 60W

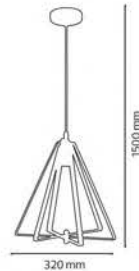

E27



**NEWTON**

021 010 0001

СКЛАДНОЙ



**BLACK**

- 250V~/4A
- Max. 60W



E27

**NOBEL**

021 013 0001

СКЛАДНОЙ



**BLACK**

- 250V~/4A
- Max. 60W

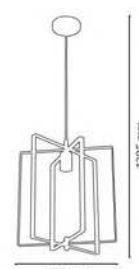

E27



**HOROZ ELECTRIC**

Декоративные подвесы

**LASER**

021 004 0001

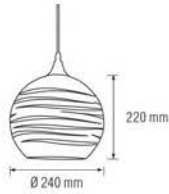

021 004 0002

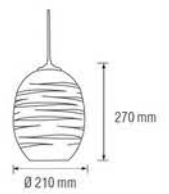

**CHROME**

- 250V~/4A
- Max. 60W
- Glass



**SPECTRUM**

021 005 0001

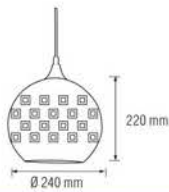

021 005 0002

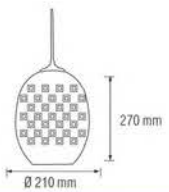

**CHROME**

- 250V~/4A
- Max. 60W
- Glass



**RADIAN**

021 007 0001

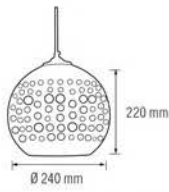

021 007 0002

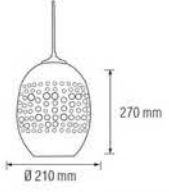

**CHROME**

- 250V~/4A
- Max. 60W
- Glass



**QUANTUM**

021 006 0001

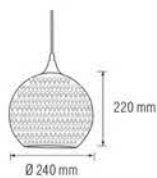

021 006 0002



**COPPER**

**CHROME**

- 250V~/4A
- Max. 60W
- Glass





**HOROZ ELECTRIC**

Декоративные подвесы / Гирлянды

**METEOR**

021 014 0001    021 014 0002

**NEW PRODUCT**

**COPPER**

**CHROME**

- 240V ~ / 4A
- Max. 60W
- Glass

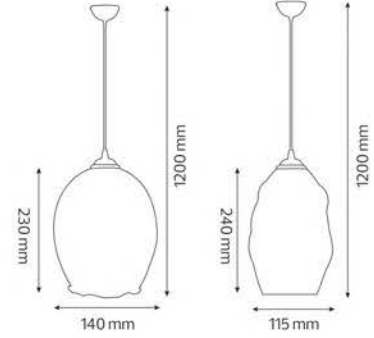

**HOROZ ELECTRIC**

Гирлянды



**CARNAVAL**

- 220V~
- На 10 ламп (Max мощность 60W)
- 10 метров
- Соединяемые
- Лампы в комплект не входят

**NEW PRODUCT**



	CARNAVAL-1	CARNAVAL-2
	022-001-0001	022-001-0002
Watt	Max. 1000W	Max. 2000W
Cable	2*0,75mm <sup>2</sup>	2*1,5mm <sup>2</sup>

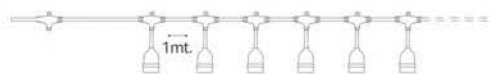



**HOGOZ ELECTRIC**

Декоративные подвесы / Гирлянды



**DREAM**

021 020 0001



**SHARP**

021 019 0001



**RONDO**

021 018 0001



**AMBER**

**TITANIUM**

- 250V~/4A
- Max. 60W
- Glass



E27

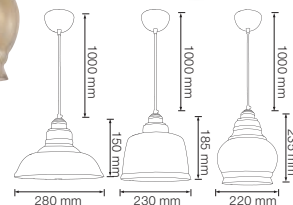

**GLOBAL**

021 021 0001



**GLOBAL-X**

021 021 0002



**AMBER**

**TITANIUM**

- 250V~/4A
- Max. 60W
- Glass



E27

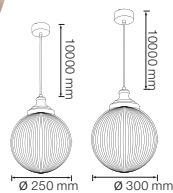

**AMPER**

021 022 0001



**COPPER**

- 250V~/4A
- Max. 60W
- For Glass Pendant

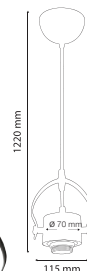

E27

**ELEMENT-1**

021 015 0001



AMBER



TITANIUM

**ELEMENT-2**

021 015 0002



CLEAR COPPER



CLEAR CHROME

- 250V~/4A
- Max. 60W
- Glass

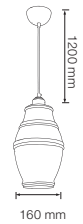

**SPARK-1**

021 016 0001



AMBER



TITANIUM

**SPARK-2**

021 016 0002



AMBER COPPER



TITANIUM COPPER

- 250V~/4A
- Max. 60W
- Glass

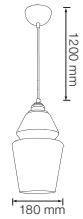

**HARMONY-1**

021 017 0001



AMBER



TITANIUM

**HARMONY-2**

021 017 0002



AMBER COPPER



TITANIUM COPPER

- 250V~/4A
- Max. 60W
- Glass

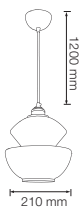

**HOROZ ELECTRIC****Декоративные  
настенно-потолочные светильники****ILGAZ**

■ 220-240V / 50-60Hz

**CHROME + MAT CHROME****Diffuser: Glass**

ILGAZ-1	ILGAZ-2	ILGAZ-3	ILGAZ-4
026-001-0001	026-001-0002	026-001-0003	026-001-0004

Power	: Max. 60 W	Max. 60 W	Max. 2x60W	Max. 60 W
Sizes (mm)	: A: 90 B: 245	A: 90 B: 290	A: 105 B: 350	A: 310 B: 110 C: 160

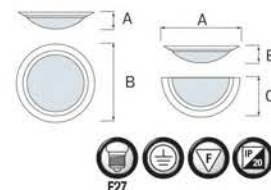
**KONAK**

■ 220-240V / 50-60Hz

**CHROME + MAT CHROME****Diffuser: Glass**

KONAK-1	KONAK-2	KONAK-3	KONAK-4
026-002-0001	026-002-0002	026-002-0003	026-002-0004

Power	: Max. 60 W	Max. 60 W	Max. 2X60W	Max. 60 W
Sizes (mm)	: A: 90 B: 220	A: 95 B: 260	A: 120 B: 330	A: 300 B: 110 C: 140

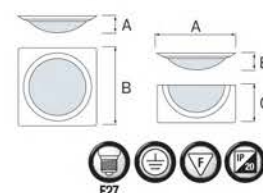
**ZARA**

■ 220-240V / 50-60Hz

**MAT CHROME****Diffuser: Glass**

ZARA-1	ZARA-2	ZARA-3	ZARA-4
026-003-0001	026-003-0002	026-003-0003	026-003-0004

Power	: Max. 60 W	Max. 2X60 W	Max. 3X60 W	Max. 60 W
Sizes (mm)	: A: 90 B: 230	A: 100 B: 285	A: 130 B: 370	A: 265 B: 110 C: 150

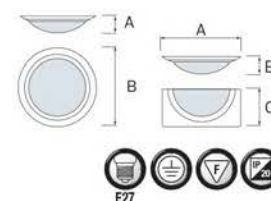
**LICE**

■ 220-240V / 50-60Hz

**MAT CHROME****Diffuser: Glass**

LICE-1	LICE-2
026-004-0001	026-004-0002

Power	: Max. 60 W	Max. 2X60 W
Sizes (mm)	: A: 35 B: 330	A: 35 B: 420

**HOROZ ELECTRIC****Декоративные  
настенно-потолочные  
светильники****SARAY**

■ 220-240V / 50-60Hz

**MAT CHROME****Diffuser: Glass**

SARAY-1	SARAY-2	SARAY-3
026-005-0001	026-005-0002	026-005-0003

Power	: Max. 40 W	Max. 60 W	Max. 2X60 W
Sizes (mm)	: A: 70 mm B: 180	A: 73 B: 235	A: 75 B: 285

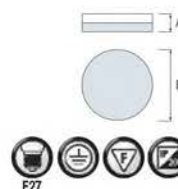



**HOROZ ELECTRIC**

## Декоративные потолочные светильники

### PHANTOM

- 185-265V / 50-60Hz
- Срок службы 30 000 Часов
- 6400K

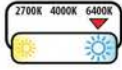

- WHITE
- BLUE
- PINK



PHANTOM-36	PHANTOM-48
027-002-0036	027-002-0048

Power	: 36 W	48 W
Luminous Flux	: 2500 lm	3330 lm
Sizes (mm)	: A: 410 B: 65	A: 510 B: 65

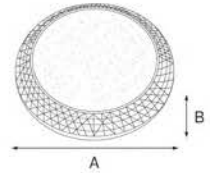

**HOROZ ELECTRIC**

## LED Потолочные светильники



### GHOST

- 185-265V / 50-60Hz
- Срок службы 30 000 Часов
- 6400K

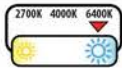

- WHITE
- BLUE
- PINK



GHOST-36	GHOST-48
027-003-0036	027-003-0048

Power	: 36 W	48 W
Luminous Flux	: 2500 lm	3330 lm
Sizes (mm)	: A: 400 B: 60	A: 490 B: 60

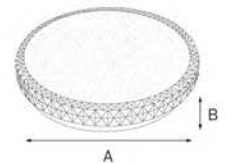



**HOROSZ ELECTRIC**

## Декоративные настенно-потолочные светильники

### SHARK-24

027 001 0024

WHITE

- 160-265V / 50-60Hz
- Срок службы 30 000 Часов
- 1800 lm
- 6400K

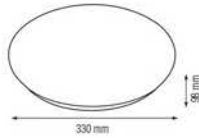

### PHOTON-15

027 005 0015

WHITE

- 120-265V / 50-60Hz
- Срок службы 30 000 Часов
- 1086 lm
- 6400K

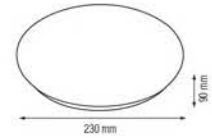

### EPSILON

- 185-265V / 50-60Hz
- Срок службы 30 000 Часов
- 6400 K

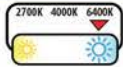

WHITE



	EPSILON-15	EPSILON-24	EPSILON-36
	027-004-0015	027-004-0024	027-004-0036

Power	: 15 W	24 W	36 W
Luminous Flux	: 1125 lm	1800 lm	2700 lm
Sizes (mm)	: A: 260 B: 55	A: 330 B: 60	A: 410 B: 60

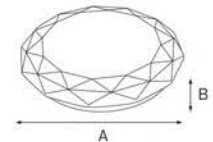



**SISAM**

029 006 0008

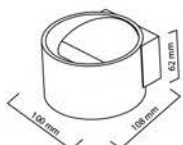

**TRUVA**

029 007 0008

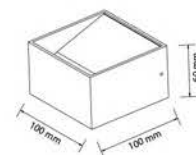

**WHITE**  
**BLACK**

- 100-240V / 50-60Hz
- 8W
- 4200K
- 320 lm (SISAM) / 520 lm (TRUVA)
- Срок службы 30 000 Часов

LED Настенные  
светильники



**ERDEK**

029 001 0005



**WHITE**  
**RED**

- 220-240V / 50-60Hz
- 5W, 325 lm
- 4000K
- Срок службы 30 000 Часов

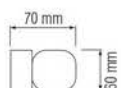

275 mm



**ABANT**

029 005 0010



**WHITE**

- 85-265V / 50-60Hz
- 10W
- 825 lm
- 4200K
- Срок службы 30 000 Часов

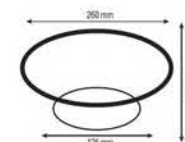

**HOROZ ELECTRIC**

LED настенные светильники

**RODOS**

- 85-265V / 50-60Hz
- Срок службы 30 000 Часов
- 4000K

WHITE

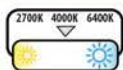

RODOS-3	RODOS-6	RODOS-12
029-004-0003	029-004-0006	029-004-0012

Power	: 3 W	6 W	12 W
Luminous Flux	: 170 lm	340 lm	950 lm
Sizes (mm)	: A: 200 B: 55 C: 100 D: 80	A: 300 B: 59 C: 179 D: 80	A: 480 B: 58 C: 345 D: 80

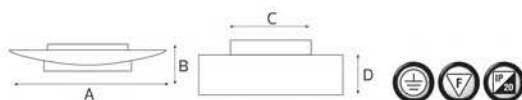
**BELEN**

- 85-265V / 50-60Hz
- Срок службы 30 000 Часов
- 4000K

WHITE

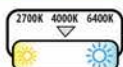

BELEN-6	BELEN-12	BELEN-18
029-003-0006	029-003-0012	029-003-0018

Power	: 6 W	12 W	18 W
Luminous Flux	: 340 lm	950 lm	1400 lm
Sizes (mm)	: A: 250 B: 105 C: 95	A: 420 B: 105 C: 95	A: 580 B: 105 C: 95

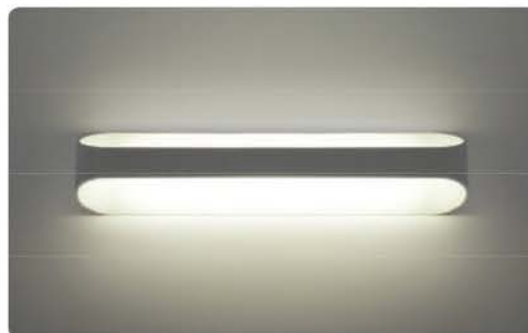



**HOZ ELECTRIC**

## LED Потолочные светильники / потолочные светильники

**LIKYA**

**CHROME**

220-240V / 50-60Hz  
4000K

Срок службы 30 000 Часов



LIKYA-1



LIKYA-2



LIKYA-3



LIKYA-4



LIKYA-5



LIKYA-6



	LIKYA-1	LIKYA-2	LIKYA-3	LIKYA-4	LIKYA-5	LIKYA-6
	036-007-0001	036-007-0002	036-007-0003	036-007-0004	036-007-0005	036-007-0006
Power	5W	2x5W	3x5W	4x5W	4x5W	6x5W
Luminous Flux	300 lm	2x300 lm	3x300 lm	4x300 lm	4x300 lm	6x300 lm

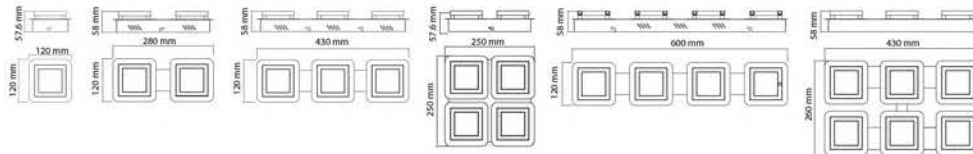

**HOZ ELECTRIC**

## LED Потолочные светильники



**HOROZ ELECTRIC****LED Потолочные светильники /  
потолочные светильники****DIDIM****CHROME**

- 220-240V / 50-60Hz
- 4000K

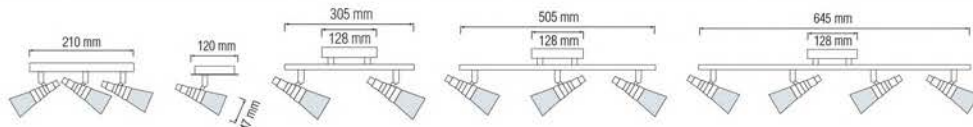

	DIDIM-1	DIDIM-2	DIDIM-3	DIDIM-4	DIDIM-5
	036-005-0001	036-005-0002	036-005-0003	036-005-0004	036-005-0005
Power	3x5W	5W	2x5W	3x5W	4x5W
Luminous Flux	3x400 lm	400 lm	2x400 lm	3x400 lm	4x400 lm

**MILAS****CHROME**

- 220-240V / 50-60Hz
- 4000K



	MILAS-1	MILAS-2	MILAS-3	MILAS-4	MILAS-5
	036-004-0001	036-004-0002	036-004-0003	036-004-0004	036-004-0005
Power	3x5W	5W	2x5W	3x5W	4x5W
Luminous Flux	3x400 lm	400 lm	2x400 lm	3x400 lm	4x400 lm

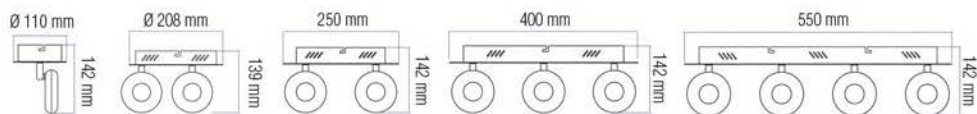

## LARA

CHROME

220-240V / 50-60Hz  
4000K



LARA-1



LARA-2



LARA-3



LARA-4



LARA-5



	LARA-1	LARA-2	LARA-3	LARA-4	LARA-5
	036-002-0001	036-002-0002	036-002-0003	036-002-0004	036-002-0005
Power	3x4W	4W	2x4W	3x4W	4x4W
Luminous Flux	3x260 lm	260 lm	2x260 lm	3x260 lm	4x260 lm

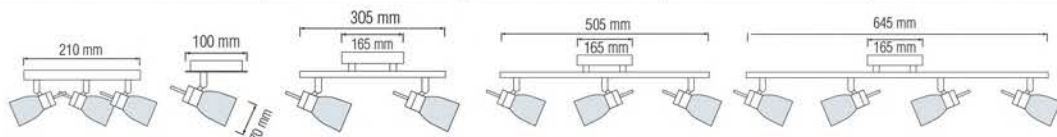

## SIDE

CHROME

220-240V / 50-60Hz  
4000K



SIDE-1



SIDE-2



SIDE-3



SIDE-4



SIDE-5



	SIDE-1	SIDE-2	SIDE-3	SIDE-4	SIDE-5
	036-003-0001	036-003-0002	036-003-0003	036-003-0004	036-003-0005
Power	3x5W	5W	2x5W	3x5W	4x5W
Luminous Flux	3x325 lm	325 lm	2x325 lm	3x325 lm	4x325 lm

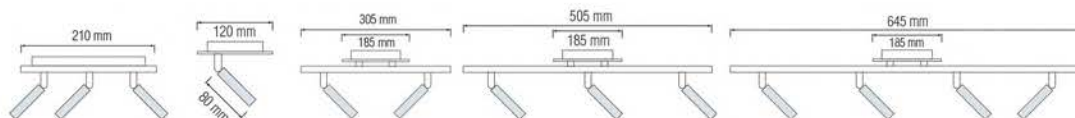

**HOGOZ ELECTRIC****LED Потолочные светильники /  
потолочные светильники****PATARA****CHROME**■ 220-240V / 50-60Hz  
■ 4000K

■ PATARA-1



■ PATARA-2



■ PATARA-3



■ PATARA-4



■ PATARA-5

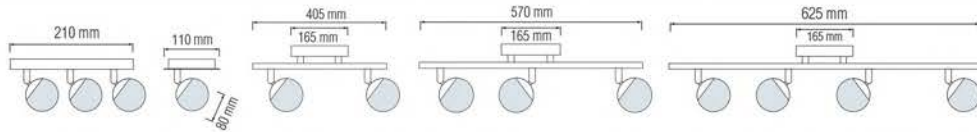

	PATARA-1	PATARA-2	PATARA-3	PATARA-4	PATARA-5
	036-001-0001	036-001-0002	036-001-0003	036-001-0004	036-001-0005
Power	3x4W	4W	2x4W	3x4W	4x4W
Luminous Flux	3x260 lm	260 lm	2x260 lm	3x260 lm	4x260 lm

**EFES****CHROME**

■ 220-240V / 50-60Hz



■ EFES-1



■ EFES-2



■ EFES-3



■ EFES-4



	EFES-1	EFES-2	EFES-3	EFES-4
	035-006-0001	035-006-0002	035-006-0003	035-006-0004
Power	Max.40W	Max.2x40W	Max.3x40W	Max.4x40W

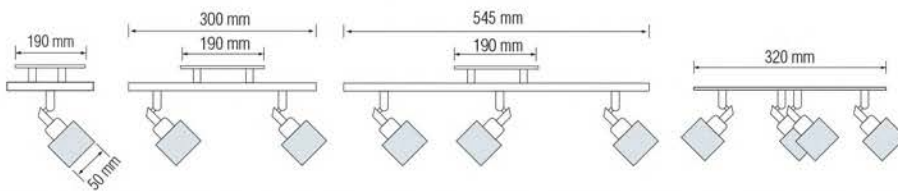

**HOROZ ELECTRIC****LED Потолочные светильники /  
потолочные светильники****MANAVGAT****CHROME**

■ 220-240V / 50-60Hz



■ MANAVGAT-1



■ MANAVGAT-2



■ MANAVGAT-5



■ MANAVGAT-3



■ MANAVGAT-4

	MANAVGAT-1	MANAVGAT-2	MANAVGAT-3	MANAVGAT-4	MANAVGAT-5
	035-003-0001	035-003-0002	035-003-0003	035-003-0004	035-003-0005
Power	Max.40W	Max.2x40W	Max.3x40W	Max.4x40W	Max.3x40W

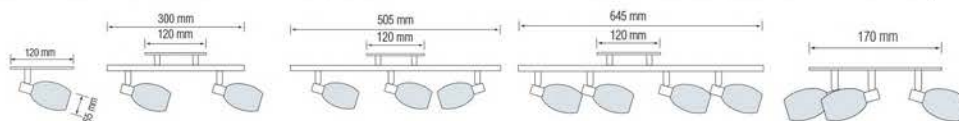

E14

**BODRUM****CHROME**

■ 220-240V / 50-60Hz



■ BODRUM-1



■ BODRUM-2



■ BODRUM-3



■ BODRUM-4

	BODRUM-1	BODRUM-2	BODRUM-3	BODRUM-4
	035-004-0001	035-004-0002	035-004-0003	035-004-0004
Power	Max.40W	Max.2x40W	Max.3x40W	Max.4x40W



E14

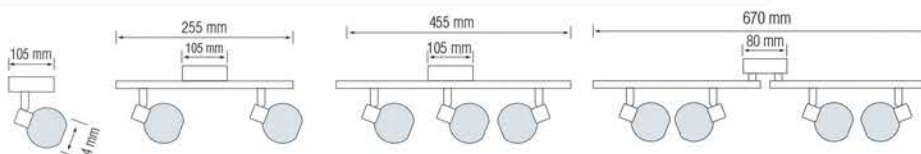

**HOZ ELECTRIC****LED Потолочные светильники /  
потолочные светильники****KEMER****CHROME**

■ 220-240V / 50-60Hz



■ KEMER-1



■ KEMER-2



■ KEMER-5



■ KEMER-3



■ KEMER-4

	KEMER-1	KEMER-2	KEMER-3	KEMER-4	KEMER-5
	035-005-0001	035-005-0002	035-005-0003	035-005-0004	035-005-0005
Power	Max.40W	Max.2x40W	Max.3x40W	Max.4x40W	Max.3x40W

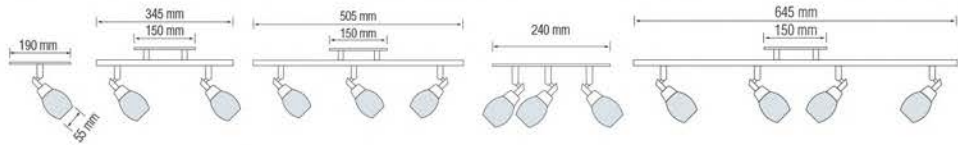
**BERGAMA****CHROME**

■ 220-240V / 50-60Hz



■ BERGAMA-1



■ BERGAMA-2



■ BERGAMA-3



■ BERGAMA-4



■ BERGAMA-5

	BERGAMA-1	BERGAMA-2	BERGAMA-3	BERGAMA-4	BERGAMA-5
	035-002-0001	035-002-0002	035-002-0003	035-002-0004	035-002-0005
Power	Max.3x40W	Max.40W	Max.2x40W	Max.3x40W	Max.4x40W

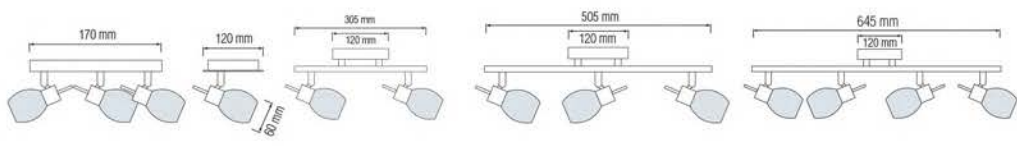





**HOROZ ELECTRIC**

Светильники для ванной комнаты /  
Подсветка зеркал и картин

**AQUA**



**CHROME**

■ 220-240V / 50-60Hz



E14

<b>AQUA-1</b>	<b>AQUA-3</b>
037-001-0001	037-001-0003

Power	:	Max.40W		Max.3x40W
-------	---	---------	--	-----------

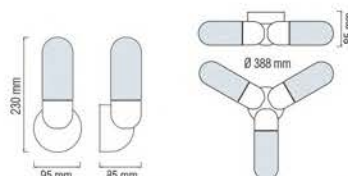

**VODA**



**CHROME**

■ 220-240V / 50-60Hz



E14

<b>VODA-1</b>	<b>VODA-3</b>
037-002-0001	037-002-0003

Power	:	Max.40W		Max.3x40W
-------	---	---------	--	-----------

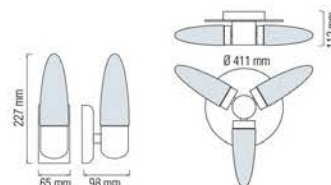

**HOROZ ELECTRIC**

Светильники для  
ванной / Подсветка  
зеркал и картин





**HOROSZ ELECTRIC**

Светильники для ванной комнаты /  
Подсветка зеркал и картин

**TOYGAR-12**

040 013 0012



**CHROME**

- 100-250V / 50-60Hz
- 1100 lm
- 4200K
- Срок службы 30 000 Часов

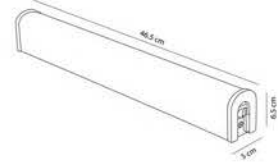

**SUMRU-12**

040 011 0012



**CHROME**

- 85-265V / 50-60Hz
- 1135 lm
- 4200K
- Срок службы 30 000 Часов

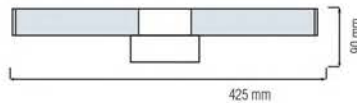

**EBABIL-12**

040 010 0012



**CHROME**

- 85-265V / 50-60Hz
- 1135 lm
- 4200K
- Срок службы 30 000 Часов



**HOROSZ ELECTRIC**

# Светильники для ванной комнаты / Подсветка зеркал и картин

**ANKA**

- 100-250V / 50-60Hz
- Срок службы 30 000 Часов
- 4200 K

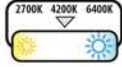
**CHROME**

ANKA-8	ANKA-12
040-014-0008	040-014-0012

Power	: 8 W	12 W
Luminous Flux	: 570 lm	850 lm
Sizes (mm)	: A: 400 B: 52 C: 185	A: 550 B: 52 C: 185

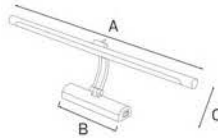
**KANARYA**

- 100-250V / 50-60Hz
- Срок службы 30 000 Часов
- 4200 K

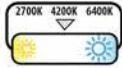
**CHROME**

KANARYA-8	KANARYA-12
040-012-0008	040-012-0012

Power	: 8 W	12 W
Luminous Flux	: 570 lm	850 lm
Sizes (mm)	: A: 405 B: 120 C: 120	A: 555 B: 120 C: 120

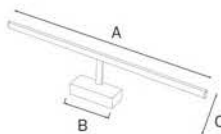

## FLAMINGO

- 100-250V / 50-60Hz
- Срок службы 30 000 Часов
- 4200 K

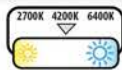

FLAMINGO-4	FLAMINGO-6
040-001-0004	040-001-0006

Power	: 4 W / 21 LED	6 W / 30 LED
Luminous Flux	: 360 lm	500 lm
Sizes (mm)	: A: 405 B: 52 C: 175	A: 505 B: 52 C: 185

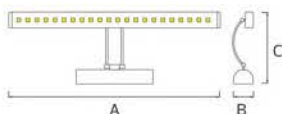

CHROME



ON-OFF

## ALBATROS

- 100-250V / 50-60Hz
- Срок службы 30 000 Часов
- 4200 K

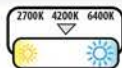

ALBATROS-4	ALBATROS-6
040-002-0004	040-002-0006

Power	: 4 W / 21 LED	6 W / 30 LED
Luminous Flux	: 360 lm	500 lm
Sizes (mm)	: A: 407 B: 55 C: 100	A: 555 B: 55 C: 108

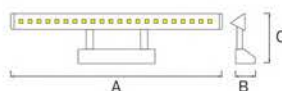

CHROME



ON-OFF

## LORI

- 85-265V / 50-60Hz
- Срок службы 30 000 Часов
- 4200 K

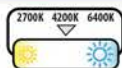

LORI-6	LORI-9
040-008-0006	040-008-0009

Power	: 6 W / 12 LED	9 W / 18 LED
Luminous Flux	: 360 lm	540 lm
Sizes (mm)	: A: 300 B: 180 C: 210	A: 380 B: 180 C: 210

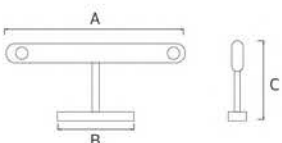

CHROME



ON-OFF

## FLORYA

- 100-265V / 50-60Hz
- Срок службы 30 000 Часов
- 4000 K

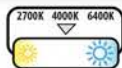

FLORYA-3	FLORYA-6	FLORYA-9
040-009-0003	040-009-0006	040-009-0009

Power	: 3 W	6 W	9 W
Luminous Flux	: 214 lm	428 lm	640 lm



CHROME



ON-OFF



**HOROZ ELECTRIC**

# Светильники для ванной комнаты / Подсветка зеркал и картин

## KUĞU

040 006 0003

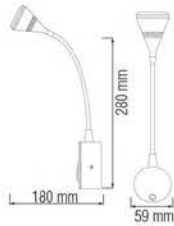

## TURNA

040 007 0003



### SILVER

- 220-240V / 50-60Hz
- 200 lm
- 4200K
- Срок службы 30 000 Часов



## SAKA

040 004 0003

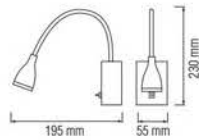

## MARTI

040 005 0003

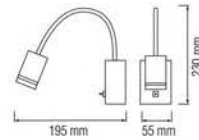

### RED

### WHITE

### BLACK

- 220-240V / 50-60Hz
- 130 lm
- 3000K
- Срок службы 30 000 Часов



## KUMRU

039 001 0001

### CHROME

### GOLDEN

### MAT CHROME

### TITANIUM BLACK



- Встроенный электронный трансформатор
- 220-240V / 50-60Hz 12V
- Max. 2x20W, 500 lm

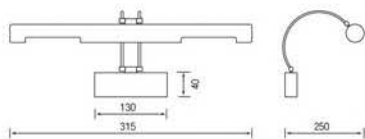

2x20W

## HL 651

### CHROME

### MAT CHROME

- Встроенный электронный трансформатор
- 220-240V / 50-60Hz 12V
- Max. 2x20W (JC)
- Max. 2x35W (MR11)

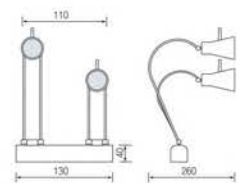

2x20W

**HORUZ ELECTRIC**

Торшеры / LED Торшеры

**TUNA**

046 001 0003

**ARAS**

046 002 0003

**DICLE**

046 003 0003



RED

WHITE

BLACK

- 220-240V / 50-60Hz
- 3W, 130 lm
- 3000K
- Срок службы 25 000 Часов

**HORUZ ELECTRIC**

Торшеры / LED Торшеры

**MERİÇ**

220-240V / 50-60Hz



MERİÇ-1	MERİÇ-2	MERİÇ-3
045-001-0001	045-001-0002	045-001-0003

Power	: Max. 100 W	Max. 100 W (Mother) Max. 40 W (Baby)	Max. 100 W (Mother) Max. 40 W (Baby)
Lamp Holder	: E27	E27 (Mother) & E14 (Baby)	E27 (Mother) & E14 (Baby)
Color	: Blue / White / Green Orange	White	White
Sizes (mm)	: A: 250 B: 1800	A: 250 B: 1800 C: 500	A: 285 B: 1800 C: 500

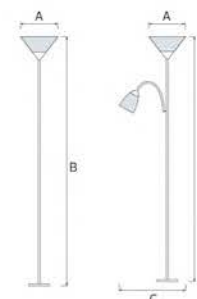

**ASTRO**

049 026 0006

- WHITE
- YELLOW
- PINK

**JUMBO**

049 027 0006

- WHITE
- BLUE
- PINK

**FELIX**

049 028 0006

- WHITE
- BLUE
- PINK

**SNOOPY**

049 029 0006

- WHITE
- BLUE
- PINK

- 100-240V / 50-60Hz
- 6 W
- 350 lm
- 3000K-4500K-6000K
- Average Life: 30.000 Hrs

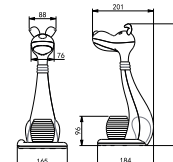
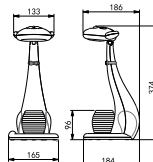
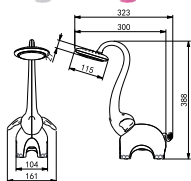
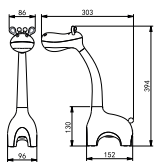
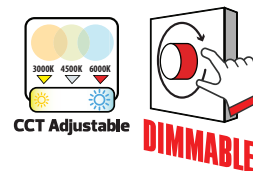

**EBRU** 049 010 0010

BLACK  
WHITE  
SILVER

- 100-240V / 50-60Hz
- 600 lm
- 3000K - 4500K - 6000K
- Срок службы 30 000 Часов

TOUCH

With Clips

10W SMD LED CCT Adjustable



**MERVE** 049 009 0005

BLUE  
YELLOW  
PINK

- 100-240V / 50-60Hz
- 300 lm
- 4600K
- Срок службы 30 000 Часов

TOUCH

5W SMD LED

**IREM** 049 011 0005

RED  
WHITE  
BLACK

- 100-240V / 50-60Hz
- 300 lm
- 4600K
- Срок службы 30 000 Часов

TOUCH

5W SMD LED

**DILARA** 049 004 0003

RED  
WHITE  
BLACK

- 220-240V / 50-60Hz
- 130 lm
- 3000K
- Срок службы 30 000 Часов

ON-OFF

3W POWER LED

**BUKET** 049 005 0003

RED  
WHITE  
BLACK

- 220-240V / 50-60Hz
- 130 lm
- 3000K
- Срок службы 30 000 Часов

ON-OFF

3W POWER LED



**BERNA** 049 006 0003

BLACK  
WHITE  
BLUE  
RED

- 220-240V / 50-60Hz
- 130 lm
- 3000K
- Срок службы 30 000 Часов

98 mm  
535 mm  
135 mm

3W POWER LED 3000K 4000K 6000K

ON-OFF



**BİLGE** 049 008 0003

BLACK  
WHITE  
BLUE  
RED  
GREEN

- 220-240V / 50-60Hz
- 130 lm
- 3000K
- Срок службы 30 000 Часов

390 mm  
115 mm

3W POWER LED 3000K 4000K 6000K

ON-OFF

**BEYZA** 049 002 0003

RED  
WHITE  
BLACK

- 220-240V / 50-60Hz
- 130 lm
- 3000K
- Срок службы 30 000 Часов

270 mm  
100 mm

3W POWER LED 3000K 4000K 6000K

ON-OFF

**ALEYNA** 049 003 0003

RED  
WHITE  
BLACK

- 220-240V / 50-60Hz
- 130 lm
- 3000K
- Срок службы 30 000 Часов

370 mm  
127 mm

3W POWER LED 3000K 4000K 6000K

ON-OFF

**ECE** 049 001 0003

RED  
WHITE  
BLACK

- 220-240V / 50-60Hz
- 130 lm
- 3000K
- Срок службы 30 000 Часов

370 mm  
127 mm

3W POWER LED 3000K 4000K 6000K

ON-OFF

**BUDDY** 048 001 0015

**PINK**  
**BLUE**  
**YELLOW**

- 220-240V / 50-60Hz
- 15W
- 4500K
- 500 lm

430 mm  
195 mm

Bulb Included

G10q ON-OFF

**OSCAR** 048 002 0015

**PINK**  
**WHITE**  
**YELLOW**

- 220-240V / 50-60Hz
- 15W
- 4500K
- 500 lm

450 mm  
230 mm

Bulb Included

G10q ON-OFF

**TOBY** 048 003 0015

**ORANGE**  
**BLUE**  
**YELLOW**

- 220-240V / 50-60Hz
- 15W
- 4500K
- 500 lm

400 mm  
205 mm

Bulb Included

G10q ON-OFF

**KITTY** 048 004 0011

**PINK**  
**BLUE**  
**GREEN**

- 220-240V / 50-60Hz
- Max. 11W, 350 lm

375 mm  
185 mm

Bulb Included

PL G23 ON-OFF

**FLYER** 048 008 0011

**PINK**  
**BLUE**  
**YELLOW**

- 220-240V / 50-60Hz
- Max. 11W, 350 lm

365 mm  
312 mm

Bulb Included

PL G23 ON-OFF

**APPLE** 048 006 0011

**PINK**  
**BLUE**  
**YELLOW**

- 220-240V / 50-60Hz
- Max. 11W, 350 lm

330 mm  
200 mm 165 mm

Bulb Included

PL G23 ON-OFF

**DONALD** 048 007 0011

**BLUE**  
**ORANGE**  
**GREEN**

- 220-240V / 50-60Hz
- Max. 11W, 350 lm

460 mm  
360 mm

Bulb Included

PL G23 ON-OFF



**DERYA** 048 010 0060

BLACK  
WHITE  
RED

220-240V / 50-60Hz  
Max. 60W



E27 ON-OFF

**DENİZ** 048 011 0040

BLACK  
WHITE  
RED

220-240V / 50-60Hz  
Max. 40W



E14 ON-OFF

**BIHTER** 048 009 0060

BLACK  
WHITE  
RED  
BLUE

220-240V / 50-60Hz  
Max. 60W



E27 ON-OFF

**RANA** 048 013 0060

BLACK  
WHITE  
RED

220-240V / 50-60Hz  
Max. 60W



E27 ON-OFF



**SİMGE** 048 014 0060

GREEN  
BLUE

220-240V / 50-60Hz  
Max. 60W



E27 ON-OFF



LED Ночники



**SIMPSON**

085 001 0006

**WHITE**

- 220-240V / 50-60Hz
- 25 lm
- Average Life: 20.000 Hrs

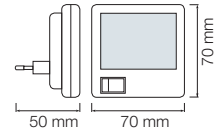

- 220-240V / 50-60Hz
- Average Life: 20.000 Hrs

**MIX (WHITE/BLUE/GREEN/RED)**

**DORA**

**REX**

**BUGS**

**MAX**

**DUFFY**



	DORA	REX	BUGS	MAX	DUFFY
	085-001-0001	085-001-0002	085-001-0003	085-001-0004	085-001-0005
Power	: 0.4 W	: 0.4 W	: 0.3 W	: 0.4 W	: 0.3 W
Luminous Flux	: 25 lm	: 25 lm	: 20 lm	: 25 lm	: 20 lm

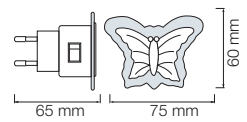
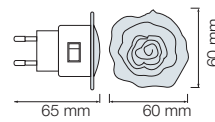
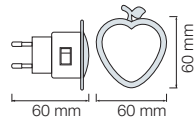
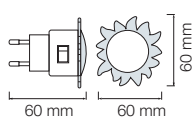
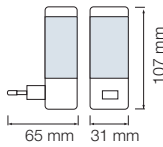

**HOROSZ ELECTRIC****LED Линейные светильники****TETRA**

- 200-240V / 50-60Hz
- Срок службы 20 000 Часов
- 6400K

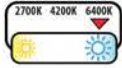

TETRA-18	TETRA-36
052-003-0060	052-003-0120

Power	: 18 W	36 W
Luminous Flux	: 1135 lm	2269 lm
Length (mm)	: L: 600	L: 1200

**HOROSZ ELECTRIC****LED Линейные светильники****SIGMA**

- 220-240V / 50-60Hz
- Срок службы 20 000 Часов
- 6400K



SIGMA-4	SIGMA-7	SIGMA-10	SIGMA-14
052-001-0030	052-001-0060	052-001-0090	052-001-0120

Power	: 4 W	7 W	10 W	14 W
Luminous Flux	: 254 lm	552 lm	846 lm	1100 lm
Length (mm)	: L: 282	L: 546	L: 856	L: 1156

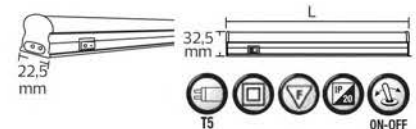
**OMEGA**

- 220-240V / 50-60Hz
- Срок службы 20 000 Часов
- 6400K



OMEGA-6	OMEGA-9	OMEGA-12	OMEGA-16
052-002-0030	052-002-0060	052-002-0090	052-002-0120

Power	: 6 W	9 W	12 W	16 W
Luminous Flux	: 273 lm	538 lm	898 lm	1136 lm
Length (mm)	: L: 285	L: 535	L: 855	L: 1155

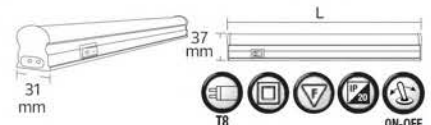

**HORUZ ELECTRIC****LED Пылевлагозащищённые линейные светильники****IRMAK**

- 170-265V/50-60Hz
- Срок службы 20 000 Часов
- 6400K

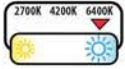

IRMAK-18	IRMAK-36	IRMAK-45
059-004-0018	059-004-0036	059-004-0045

Power	: 18 W	36 W	45 W
Luminous Flux	: 1440 lm	2880 lm	3600 lm
Length	: L: 650 mm	L: 1260 mm	L: 1560 mm

**NEHIR**

- 170-265V/50-60Hz
- Срок службы 20 000 Часов
- 4200K / 6400K

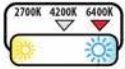

NEHIR-18	NEHIR-36	NEHIR-45
059-003-0018	059-003-0036	059-003-0045

Power	: 18 W	36 W	45 W
Luminous Flux	: 1440 lm	2880 lm	3600 lm
Length (mm)	: L: 652	L: 1262	L: 1562

**HORUZ ELECTRIC****LED Пылевлагозащищённые светильники****OKYANUS**

- 170-265V/50-60Hz
- Срок службы 20 000 Часов
- 6400K

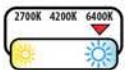

OKYANUS-36	OKYANUS-72	OKYANUS-90
059-005-0036	059-005-0072	059-005-0090

Power	: 36 W	72 W	90 W
Luminous Flux	: 2880 lm	5760 lm	7200 lm
Length (mm)	: L: 632	L: 1242	L: 1542





**HOROSZ ELECTRIC**

LED пылевлагозащищённые линейные светильники

**MEDUSA**

- 220-240V / 50-60Hz
- Average Life: 40.000 Hrs
- 6400K

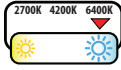

MEDUSA-18	MEDUSA-36	MEDUSA-58
059-006-0018	059-006-0036	059-006-0058

Power	: 18 W	36 W	58 W
Luminous Flux	: 1800 lm	3600 lm	5800 lm
Length (mm)	: L: 600	L: 1200	L: 1500



**PROFIX**

- 175-250V / 50-60Hz
- For 60/120 cm double side energized LED Tubes
- LED Tube not included



PROFIX-60S	PROFIX-60D	PROFIX-120S	PROFIX-120D
057-001-1060	057-001-2060	057-001-1120	057-001-2120

Power	: Max. 20W	Max.2x20W	Max.40W	Max.2x40W
Lamp Holder	: T8	2xT8	T8	2xT8
Sizes (mm)	: A: 670 B: 65 C: 65	A: 670 B: 95 C: 65	A: 1280 B: 65 C: 65	A: 1280 B: 95 C: 65

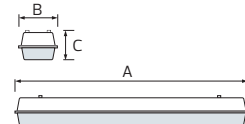

**TUBOFIX**

- 175-250V / 50-60Hz
- For 60/120 cm double side energized LED Tubes
- LED Tube not included



TUBOFIX-60	TUBOFIX-60D	TUBOFIX-120	TUBOFIX-120D
061-001-0060	061-001-2060	061-001-0120	061-001-2120

Power	: Max. 20W	Max.2x20W	Max.40W	Max.2x40W
Lamp Holder	: T8	2xT8	T8	2xT8
Length (mm)	: L: 616	L: 616	L: 1226	L: 1226

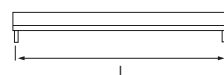
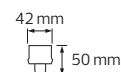

## ZEUGMA

- 100-265V / 50-60Hz
- Average Life: 50.000 Hrs
- 6400K
- Aluminium Die Casting Body

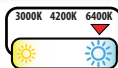

**Mountable**



**Hangable**



	ZEUGMA-50	ZEUGMA-100	ZEUGMA-150	ZEUGMA-200
	063-005-0050	063-005-0100	063-005-0150	063-005-0200
Power	50 W	100 W	150 W	200 W
Luminous Flux	4650	9300	13950	18600
Length (mm)	290	520	758	1000

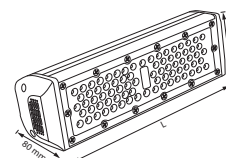





**HOGOZ ELECTRIC**

## Подвесные промышленные светильники

**ZEUS**

062 001 0015

- 220-240V / 50-60Hz
- PC
- Max. 75W



НЕБЬЮЩИЙСЯ



**AFRODIT**

062 003 0025

- |              |              |
|--------------|--------------|
| <b>RED</b>   | <b>PINK</b>  |
| <b>GREEN</b> | <b>CLEAR</b> |
| <b>BLUE</b>  |              |

- 220-240V / 50-60Hz
- PC
- Max. 100W



НЕБЬЮЩИЙСЯ



**HOGOZ ELECTRIC**

## Подвесные промышленные светильники



**APOLLON**

062 002 0015

- 220-240V / 50-60Hz
- PC
- Max. 75W



НЕБЬЮЩИЙСЯ



**EROS**

062 004 0045

- 220-240V / 50-60Hz
- PC
- Max. 200W



НЕБЬЮЩИЙСЯ



**GALYA**

062 007 0065

- 220-240V / 50-60Hz
- PC
- Max. 300W



НЕБЬЮЩИЙСЯ



**ARES**

062 006 0065

- 220-240V / 50-60Hz
- PC
- Max. 300W



НЕБЬЮЩИЙСЯ





### GORDION

- 175-250V / 50-60Hz
- Average Life: 20.000 Hrs
- 6400K
- Aluminium Die Casting Body

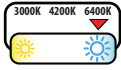

	GORDION-50	GORDION-100	GORDION-150	GORDION-200
	063-006-0050	063-006-0100	063-006-0150	063-006-0200

Power	: 50 W	100 W	150 W	200 W
Luminous Flux	: 5000 lm	10000 lm	15000 lm	20000 lm
Sizes (mm)	: A:171.9 B: 79.9	A:239.9 B: 88	A:304.9 B: 88	A:357.9 B: 88

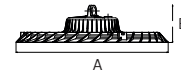

### ASPENDOS

- 100-265V / 50-60Hz
- Average Life: 25.000 Hrs
- 6400K
- Aluminium Die Casting Body

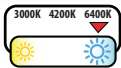

	ASPENDOS-50	ASPENDOS-100	ASPENDOS-150	ASPENDOS-200
	063-004-0050	063-004-0100	063-004-0150	063-004-0200

Power	: 50 W	100 W	150 W	200 W
Luminous Flux	: 4750 lm	9500 lm	14250 lm	19000 lm
Sizes (mm)	: A: 242.5 B: 172.5	A: 298.5 B: 175.1	A: 347.7 B: 176.8	A: 398.5 B: 178.1

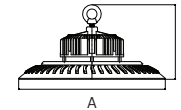

### ARTEMIS

- 85-265V / 50-60Hz
- Average Life: 30.000 Hrs
- 6400K
- Aluminium Die Casting Body

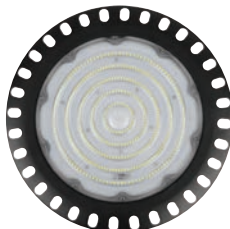
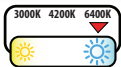

	ARTEMIS-50	ARTEMIS-100	ARTEMIS-150	ARTEMIS-200
	063-003-0050	063-003-0100	063-003-0150	063-003-0200

Power	: 50 W	100 W	150 W	200 W
Luminous Flux	: 5000 lm	10000 lm	15000 lm	20000 lm
Sizes (mm)	: A: 230 B: 120	A: 270 B: 110	A: 320 B: 125	A: 370 B: 145

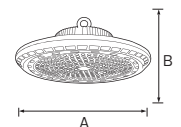



**HOROZ ELECTRIC**

LED Прожекторы

**KAPLAN-45**

068 007 0045



45W



**BLACK**

- 220-240V / 50-60Hz
- Срок службы 50 000 Часов
- 45W, 5 400lm
- 4200K

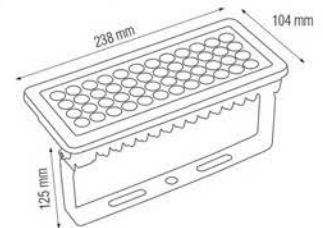

**HOROZ ELECTRIC**

LED Прожекторы



**KAPLAN-45W**

068 007 0001

крепление

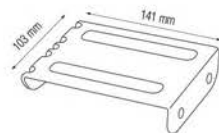

Projector Not Included

**KAPLAN-45S**

068 007 0002

крепление

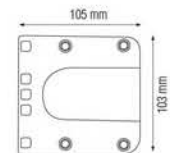

Projector Not Included

**KAPLAN-45C**

068 007 0003

крепление



Projector Not Included





**HOROZ ELECTRIC**

LED Прожекторы



**HOROZ ELECTRIC**

Прожектор и модуль  
солнечной батареи



**TIGER**

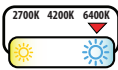

- 3.2V DC
- Average Life: 50.000 Hrs
- 6400K
- Duration Time 12-15 Hours
- Charge&Discharge: >1500 times
- Charging Time: 4-6 Hours (Cloudy 1 day, Rainy 2 days)
- Remote Control: 12m
- With 5m Cable & U Bracket

**BLACK**



	TIGER-25 068-012-0025	TIGER-40 068-012-0040	TIGER-60 068-012-0060	TIGER-100 068-012-0100
Power	: 25 W	: 40 W	: 60 W	: 100 W
Luminous Flux	: 465 lm	: 840 lm	: 1040 lm	: 1500 lm
Battery	: 1x 3.2V 5Ah Lithium Iron Phosphate	: 2 x 3.2V 5Ah Lithium Iron Phosphate	: 3 x 3.2V 5Ah Lithium Iron Phosphate	: 4 x 3.2V 5Ah Lithium Iron Phosphate
Solar Panel	: Polysilicon, 6V/12W	: Polysilicon, 6V/16W	: Polysilicon, 6V/20W	: Polysilicon, 6V/35W
Projector Sizes (mm)	: A: 170 B: 205 C: 50	: A: 210 B: 247 C: 65	: A: 223 B: 264 C: 67	: A: 265 B: 315 C: 70
Solar Panel Sizes (mm)	: D: 340 E: 175 F: 17	: D: 290 E: 340 F: 17	: D: 350 E: 350 F: 17	: D: 580 E: 360 F: 17

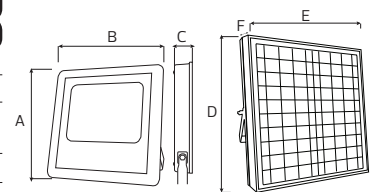



# HORUZ ELECTRIC

## LED Прожекторы

### LION

- 85-265V / 50-60Hz
- Average Life: 50.000 Hrs
- 6400K

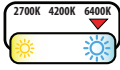

BLACK



	LION-50	LION-100	LION-150	LION-200	LION-300	LION-400	LION-500
	068-013-0050	068-013-0100	068-013-0150	068-013-0200	068-013-0300	068-013-0400	068-013-0500
Power	50 W	100 W	150 W	200 W	300 W	400 W	500 W
Luminous Flux	4250 lm	8500 lm	12750 lm	17000 lm	25500 lm	34000 lm	42500 lm
Sizes (mm)	A:201 B:240 C:70	A:223 B:272 C:78	A:450 B:272 C:78	A:450 B:400 C:78	A:450 B:500 C:90	A:560 B:610 C:94	A:560 B:720 C:98

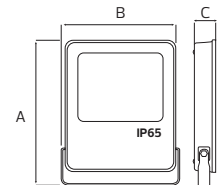

### PANTER

- 85-265V / 50-60Hz
- Average Life: 50.000 Hrs
- 2700K / 4200K / 6400K

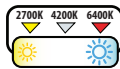

BLACK



	PANTER-50	PANTER-100	PANTER-150	PANTER-200	PANTER-300	PANTER-400
	068-005-0050	068-005-0100	068-005-0150	068-005-0200	068-005-0300	068-005-0400
Power	50 W	100 W	150 W	200 W	300 W	400 W
Luminous Flux	3750 lm	7500 lm	11250 lm	15000 lm	22500 lm	30000 lm
Sizes (mm)	A: 245 B: 297 C: 75	A: 246 B: 324 C: 75	A: 315 B: 418 C: 90	A: 314 B: 418 C: 90	A: 345 B: 525 C: 100	A: 355 B: 625 C: 100

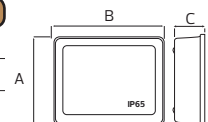



**HOROZ ELECTRIC**

LED Прожекторы



**LEOPAR**

- 85-265V / 50-60Hz
- Average Life: 50.000 Hrs

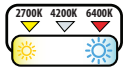

**BLACK**

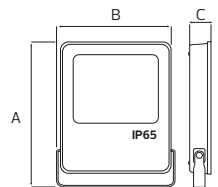

	LEOPAR-20	LEOPAR-30	LEOPAR-50	LEOPAR-100	LEOPAR-150	LEOPAR-200	LEOPAR-300	LEOPAR-400
	068-006-0020	068-006-0030	068-006-0050	068-006-0100	068-006-0150	068-006-0200	068-006-0300	068-006-0400
Power	: 20 W	: 30 W	: 50 W	: 100 W	: 150 W	: 200 W	: 300 W	: 400 W
Luminous Flux	: 1785 lm	: 2685 lm	: 4500 lm	: 8500 lm	: 13200 lm	: 19000 lm	: 25500 lm	: 34000 lm
Color Temperature	: 2700K/4200K 6400K	: 2700K/4200K 6400K	: 2700K/4200K 6400K	: 2700K/4200K 6400K	: 2700K/4200K 6400K	: 2700K/4200K 6400K	: 6400K	: 6400K
Sizes (mm)	: A:200 B:157 C:50	: A:215 B:171 C:45	: A:270 B:210 C:55	: A:305 B:253 C:75	: A:380 B:310 C:75	: A:400 B:350 C:90	: A:420 B:380 C:90	: A:480 B:430 C:105

**HOROS ELECTRIC****LED Прожекторы****ASLAN**

- 175-250V / 50-60Hz
- Срок службы 50 000 Часов

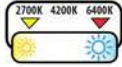
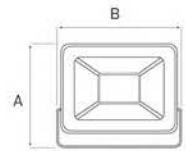
**BLACK**

	ASLAN-10	ASLAN-20	ASLAN-30	ASLAN-50	ASLAN-100	ASLAN-200
	068-010-0010	068-010-0020	068-010-0030	068-010-0050	068-010-0100	068-010-0200
Power	: 10 W	: 20 W	: 30 W	: 50 W	: 100 W	: 200 W
Luminous Flux	: 1200 lm	: 2400 lm	: 3600 lm	: 6000 lm	: 12000 lm	: 24000 lm
Color Temperature	: 2700K/6400K/GREEN	: 2700K/6400K/GREEN	: 2700K/6400K/GREEN	: 2700K/6400K/GREEN	: 2700K/6400K	: 2700K/6400K
Sizes (mm)	: A: 91,3 B: 97 C: 30,5	: A: 104,5 B: 128,4 C: 30,5	: A: 114,4 B: 154,3 C: 30,5	: A: 163,7 B: 224,3 C: 30,5	: A: 232,3 B: 294,5 C: 31	: A: 332,9 B: 420,8 C: 37

**ASLAN/S**

- 175-250V / 50-60Hz
- Срок службы 50 000 Часов
- 6400K

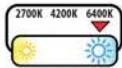
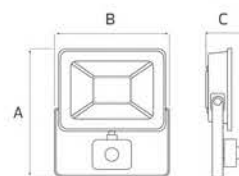
**С ДАТЧИКОМ****BLACK**

	ASLAN/S-20	ASLAN/S-30	ASLAN/S-50
	068-011-0020	068-011-0030	068-011-0050
Power	: 20 W	: 30 W	: 50 W
Luminous Flux	: 2400 lm	: 3600 lm	: 6000 lm
Sizes (mm)	: A: 171,6 B: 128,5 C: 50	: A: 180,1 B: 154,3 C: 52	: A: 226,5 B: 224,3 C: 52

**HORUZ ELECTRIC**

LED Прожекторы

**PARS**

- 220-240V / 50-60Hz
- Срок службы 50 000 Часов

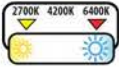
**BLACK**

	PARS-10	PARS-20	PARS-30	PARS-50	PARS-100
	068-008-0010	068-008-0020	068-008-0030	068-008-0050	068-008-0100
Power	: 10 W	: 20 W	: 30 W	: 50 W	: 100 W
Luminous Flux	: 1200 lm	: 2400 lm	: 3600 lm	: 6000 lm	: 12000 lm
Color Temperature	: 2700K/6400K/GREEN	: 2700K/6400K/GREEN	: 2700K/6400K/GREEN	: 2700K/6400K/GREEN	: 2700K/6400K
Sizes (mm)	: A: 96 B: 112 C: 25	: A: 122 B: 140 C: 28	: A: 151 B: 170 C: 30	: A: 186 B: 208 C: 33	: A: 239 B: 274 C: 42

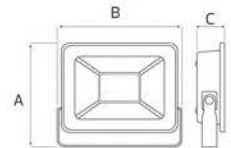
**PARS/S**

- 220-240V / 50-60Hz
- Срок службы 50 000 Часов
- 6400K

**BLACK**

	PARS/S-10	PARS/S-20	PARS/S-30	PARS/S-50	PARS/S-100
	068-009-0010	068-009-0020	068-009-0030	068-009-0050	068-009-0100
Power	: 10 W	: 20 W	: 30 W	: 50 W	: 100 W
Luminous Flux	: 1200 lm	: 2400 lm	: 3600 lm	: 6000 lm	: 12000 lm
Sizes (mm)	: A: 157 B: 112 C: 40	: A: 174 B: 140 C: 40	: A: 196 B: 170 C: 40	: A: 213.5 B: 208 C: 40	: A: 265 B: 274 C: 44

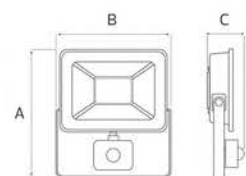



**HOROSZ ELECTRIC****LED Прожекторы****PUMA**

- 175-250V / 50-60Hz
- Срок службы 20 000 Часов

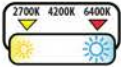
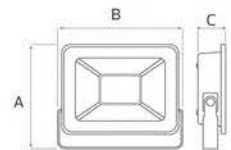
**BLACK**

	PUMA-10	PUMA-20	PUMA-30	PUMA-50	PUMA-100	PUMA-200	PUMA-300
	068-003-0010	068-003-0020	068-003-0030	068-003-0050	068-003-0100	068-003-0200	068-003-0300
Power	10 W	20 W	30 W	50 W	100 W	200 W	300 W
Luminous Flux	1200 lm	2400 lm	3600 lm	6000 lm	12000 lm	24000 lm	36000 lm
Color Temperature	2700K/6400K/GREEN	2700K/6400K/GREEN	2700K/6400K/GREEN	2700K/6400K/GREEN	2700K/6400K	2700K/6400K	2700K/6400K
Sizes (mm)	A: 94 B: 110 C: 33	A: 109 B: 129 C: 37.5	A: 128 B: 150 C: 38	A: 153 B: 182 C: 38.5	A: 220 B: 274 C: 41	A: 273 B: 330 C: 76	A: 312 B: 395 C: 95

**PUMA/S**

- 175-250V / 50-60Hz
- Срок службы 20 000 Часов
- 6400K

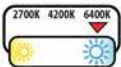
**BLACK****С ДАТЧИКОМ**

	PUMA/S-10	PUMA/S-20	PUMA/S-30	PUMA/S-50	PUMA/S-100
	068-004-0010	068-004-0020	068-004-0030	068-004-0050	068-004-0100
Power	10 W	20 W	30 W	50 W	100 W
Luminous Flux	1200 lm	2400 lm	3600 lm	6000 lm	12000 lm
Sizes (mm)	A: 134 B: 110 C: 33	A: 149 B: 129 mm C: 37.5	A: 168 B: 150 C: 38.5	A: 193 B: 182 C: 38.5	A: 260 B: 274 C: 41

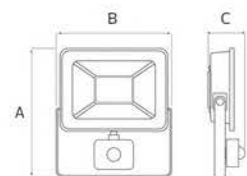



# HOROZ ELECTRIC

## LED Прожекторы

### PROPORT

- 220-240V / 50-60Hz
- Average Life: 30.000 Hrs
- 6400K
- With 1.8 meter cable

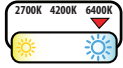

FOLDABLE

NEW PRODUCT



	PROPORT-20	PROPORT-45
	068-015-0020	068-015-0045

Power	: 20 W	45 W
Luminous Flux	: 1450 lm	3500 lm
Sizes (mm)	: A: 232.3 B: 146.4 C: 54	A: 298.6 B: 187 C: 52.5

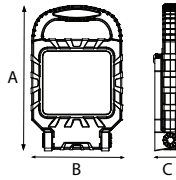

# HOROZ ELECTRIC

## Стойки под прожекторы



### PORTABLE

107 001 0003

- PORTABLE STAND
- 1.5 meter H05VV-F cable

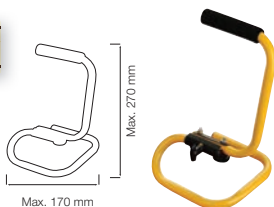

### TRIPOD SINGLE

107 001 0001

- TRIPOD SINGLE STAND
- 1.8 meter H05VV-F cable

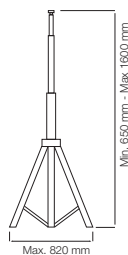

### TRIPOD DOUBLE

107 001 0002

- TRIPOD DOUBLE STAND
- 1.8 meter H05VV-F cable

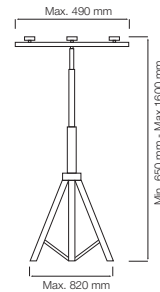



**HOROZ ELECTRIC**

## Уличные LED панели и линейные прожекторы

**FALCON**

RECESSED

**EAGLE**

SURFACED

069 001 0110

069 002 0110

- 100-240V / 50-60Hz
- 6400K
- 110W
- 11000 lm
- Срок службы 50 000 Часов

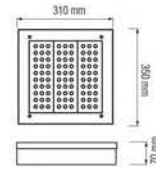
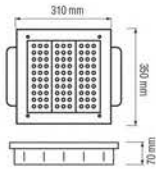

**HOROZ ELECTRIC**

## Уличные LED панели



**HOROZ ELECTRIC**

## Уличные линейные LED прожекторы



**REGAL**

AMBER 3000K RED GREEN BLUE



- 85-265V/50-60Hz
- Срок службы 50 000 Часов
- Алюминиевый корпус



	REGAL-9	REGAL-12	REGAL-18	REGAL-24	REGAL-36
	109-001-0009	109-001-0012	109-001-0018	109-001-0024	109-001-0036
Power	9 W	12 W	18 W	24 W	36 W
Luminous Flux	540 lm	720 lm	1080 lm	1440 lm	2160 lm
Length (mm)	255	330	480	630	930 mm

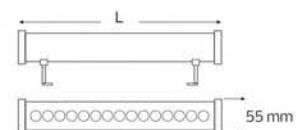

**LAGUNA**

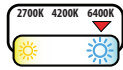

- 3.2V DC
- Average Life: 50.000 Hrs
- 6400K
- Duration Time 12-15 Hours
- Charge&Discharge: >1500 times
- Charging Time: 4-6 Hours (Cloudy 1 day, Rainy 2 days)
- Remote Control: 12m
- With 1.2m Cable, Lamp Arm & U Bracket



**BLACK**



	LAGUNA-50	LAGUNA-100	LAGUNA-200
	074-006-0050	074-006-0100	074-006-0200

Power	: 50 W	100 W	200 W
Luminous Flux	: 950 lm	1300 lm	2050 lm
Battery	: 2 x 3.2V 5Ah Lithium Iron Phosphate	3 x 3.2V 5Ah Lithium Iron Phosphate	5 x 3.2V 5Ah Lithium Iron Phosphate
Solar Panel	: Polysilicon, 6V/12W	Polysilicon, 6V/16W	Polysilicon, 6V/33W
Installation Height	: 3 Meters	3-4 Meters	4-5 Meters
Street Lamp Sizes (mm)	: A:160 B:378 C:63	A:185 B:444 C:63	A:230 B:575 C:75
Solar Panel Sizes (mm)	: D:340 E:290 F:17	D:350 E:350 F:17	D:645 E:360 F:17

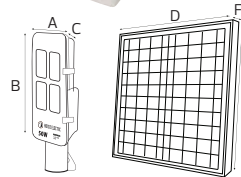



**HOGOZ ELECTRIC**

LED Уличные светильники

**ORLANDO**

- 85-265V / 50-60Hz
- Срок службы 30 000 Часов
- 6400K

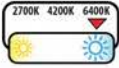

**BLACK**

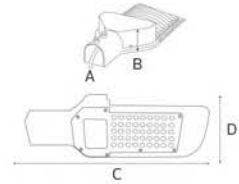

**NEW PRODUCT**

**NEW PRODUCT**



	ORLANDO-20	ORLANDO-30	ORLANDO-50	ORLANDO-100	ORLANDO-150	ORLANDO-200
	074-005-0020	074-005-0030	074-005-0050	074-005-0100	074-005-0150	074-005-0200
Power	: 20 W	: 30 W	: 50 W	: 100 W	: 150 W	: 200 W
Luminous Flux	: 1726 lm	: 2829 lm	: 4953 lm	: 8923 lm	: 15061 lm	: 17594 lm
Sizes (mm)	: A:40 B:55 C:315 D:105	: A:40 B:55 C:355 D:125	: A:40 B:55 C:405 D:165	: A:60 B:75 C:620 D:220	: A:60 B:75 C:690 D:250	: A:60 B:85 C:740 D:275



**HOGOZ ELECTRIC**

LED Уличные светильники



## YILDIZ

- 100-240V / 50-60Hz
- Пластиковый корпус
- Срок службы 30 000 Часов



WHITE

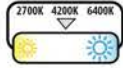

YILDIZ-8	YILDIZ-15
071-009-0008	071-009-0015

Power	: 8 W	15 W
Luminous Flux	: 560 lm	1080 lm
Sizes (mm)	: A: 76 B: 166 C: 62	A: 101 B: 201 C: 68

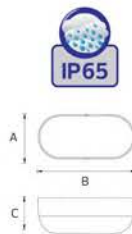

## Пылевлаго защищённые светильники



WHITE

BLACK

220-240V / 50-60Hz

NEMRUT

AYDER

TOROS

KAÇKAR



NEMRUT	AYDER	TOROS	KAÇKAR
070-001-0060	070-012-0100	070-002-0060	070-013-0100

Power	: Max.60 W	Max.100 W	Max.60 W	Max.100 W
Sizes (mm)	: A: 210 B: 80 C: 105	A: 275 B: 115 C: 155	A: 210 B: 85 C: 105	A: 275 B: 120 C: 155

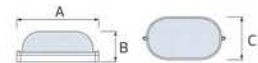

WHITE

BLACK

220-240V / 50-60Hz

ZİGANA

MUNZUR

ARARAT

ERCIYES



ZİGANA	MUNZUR	ARARAT	ERCIYES
070-005-0060	070-014-0100	070-006-0060	070-015-0100

Power	: Max.60 W	Max.100 W	Max.60 W	Max.100 W
Sizes (mm)	: A: 180 B: 85 C: 180	A: 240 B: 110 C: 140	A: 170 B: 80 C: 170	A: 240 B: 115 C: 240

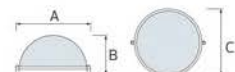



**HOROZ ELECTRIC**

Садово-парковые светильники



**HOROZ ELECTRIC**

Садово-парковые  
СВЕТИЛЬНИКИ



**NAR**

- 220-240V / 50-60Hz
- Aluminium Body
- Plastic Diffuser

**NEW  
PRODUCT**

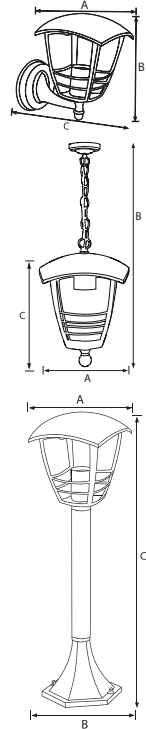

	NAR-1	NAR-2	NAR-3	NAR-4	NAR-5
	075-016-0001	075-016-0002	075-016-0003	075-016-0004	075-016-0005
Power	Max.60 W	Max.60 W	Max.60 W	Max.60 W	Max.60 W
Color	Black/White	Black/White	Black/White	Black	Black
Sizes	A: 170 B: 240 C: 210	A: 170 B: 800 C: 260	A: 170 B: 170 C: 300	A: 170 B: 170 C: 580	A: 170 B: 170 C: 840



	NAR-6	NAR-7
	075-016-0006	075-016-0007
Power	Max. 2x60 W	Max. 3x60 W
Color	Black	Black



**HORUZ ELECTRIC**

# Садово-парковые светильники

## KAVAK/SQ

- 220-240V / 50-60Hz
- Aluminium Body
- Diffuser: Glass
- Max. 60W

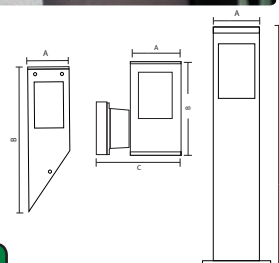

KAVAK/SQ-1	KAVAK/SQ-2	KAVAK/SQ-3	KAVAK/SQ-4	KAVAK/SQ-5
075-015-0001	075-015-0002	075-015-0003	075-015-0004	075-015-0005

Sizes (mm)	:	A: 90 B: 300	A: 90 B: 200 C: 150	A: 90 B: 300	A: 90 B: 500	A: 90 B: 800
------------	---	--------------	---------------------	--------------	--------------	--------------



## KAVAK

- 220-240V / 50-60Hz
- Aluminium Body
- Diffuser: Glass
- Max. 60W

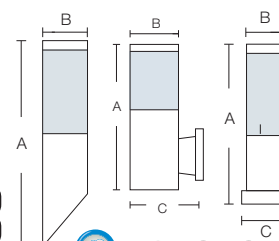

KAVAK-1	KAVAK-2	KAVAK-3	KAVAK-4	KAVAK-5
075-014-0001	075-014-0002	075-014-0003	075-014-0004	075-014-0005

Sizes (mm)	:	A: 305 B: 89	A: 208 B: 89 C: 148	A: 300 B: 89 C: 130	A: 500 B: 89 C: 110	A: 800 B: 89 C: 110
------------	---	--------------	---------------------	---------------------	---------------------	---------------------







**HOGOZ ELECTRIC**

Садово-парковые светильники

**LADiN**

- 220-240V / 50-60Hz
- Stainless Steel and Galvanized Steel Body
- Diffuser: PC
- Max. 60W

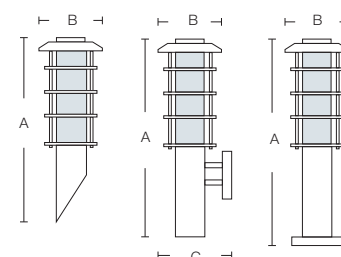

	LADiN-1	LADiN-2	LADiN-3	LADiN-4
	075-002-0001	075-002-0002	075-002-0003	075-002-0004
Sizes (mm)	A: 335 B: 120	A: 350 B: 120 C: 165	A: 500 B: 120	A: 800 B: 120



**KAYIN**

- 220-240V / 50-60Hz
- Stainless Steel and Galvanized Steel Body
- Diffuser: PC
- Max. 60W

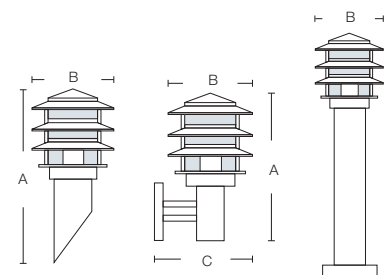

	KAYIN-1	KAYIN-2	KAYIN-3	KAYIN-4
	075-003-0001	075-003-0002	075-003-0003	075-003-0004
Sizes (mm)	A: 390 B: 150	A: 275 B: 150 B: 210	A: 450 B: 150	A: 800 B: 150





**HOROZ ELECTRIC**

## Садово-парковые светильники

### PALMIYE

- 220-240V / 50-60Hz
- Stainless Steel and Galvanized Steel Body
- Diffuser: PC
- Max. 100W

**BLACK**

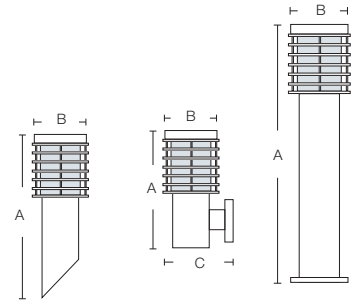
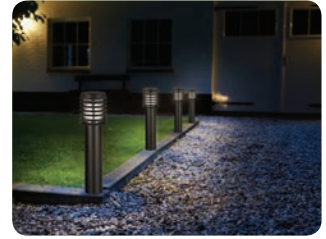

**PALMIYE-1**

075-001-0001

**PALMIYE-2**

075-001-0002

**PALMIYE-3**

075-001-0003

**PALMIYE-4**

075-001-0004

Sizes (mm)

: A: 350 B: 150

A: 320 B: 150 B: 230

A: 500 B: 150

A: 800 B: 150



### DEFNE

- 220-240V / 50-60Hz
- Stainless Steel Body
- Diffuser: PC
- Max. 60W

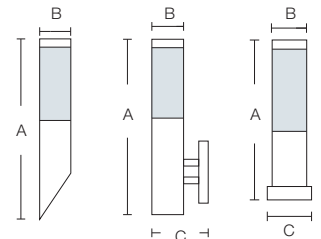

**DEFNE-1**

075-004-0001

**DEFNE-2**

075-004-0002

**DEFNE-3**

075-004-0003

**DEFNE-4**

075-004-0004

**DEFNE-5**

075-004-0005

Sizes (mm)

: A: 405 B: 76

A: 344 B: 76 C: 142

A: 325 B: 76 C: 110

A: 500 B: 76 C: 110

A: 800 B: 76 C: 110





**HOGOZ ELECTRIC**

Садово-парковые светильники

**BAMBU**

- 220-240V / 50-60Hz
- Average Life: 25.000 Hrs
- 9W
- 684 lm
- 4000K

**MAT CHROME**

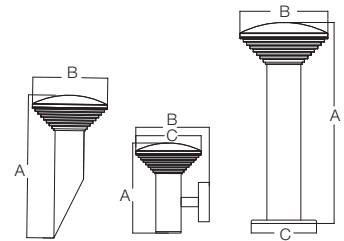
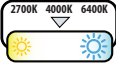

	BAMBU-1	BAMBU-2	BAMBU-3	BAMBU-4	BAMBU-5
	076-016-0001	076-016-0002	076-016-0003	076-016-0004	076-016-0005
Sizes (mm)	A: 252.2 B: 132	A: 183 B: 148.5 C: 132	A: 300 B: 132 C: 98	A: 500 B: 132 C: 98	A: 800 B: 132 C: 98



**HORIZ ELECTRIC****Садово-парковые светильники****MANGO**

- 220-240V / 50-60Hz
- Нержавеющая сталь и гальванизированный стальной корпус
- Рассеиватель из поликарбоната
- Max. 75W

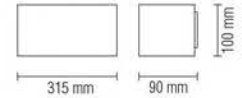

**MANGO-1**  
075-009-0001

**MANGO-2**  
075-009-0002

**MANGO-3**  
075-009-0003

**GARDENYA**

- 220-240V / 50-60Hz
- Нержавеющая сталь и гальванизированный стальной корпус
- Рассеиватель из поликарбоната

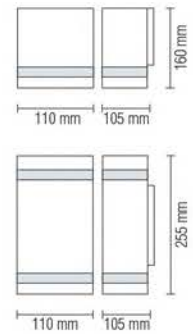

	GARDENYA-1	GARDENYA-2	GARDENYA-3	GARDENYA-4
	075-010-0001	075-010-0002	075-010-0003	075-010-0004

<b>Power</b>	:	Max.35W	Max.2x35W	Max.35W	Max.2x35W
--------------	---	---------	-----------	---------	-----------

**MANOLYA**

- 220-240V / 50-60Hz
- Нержавеющая сталь и гальванизированный стальной корпус
- Рассеиватель из стекла



	MANOLYA-1	MANOLYA-2	MANOLYA-3
	075-008-0001	075-008-0002	075-008-0003

<b>Power</b>	:	Max.35W	Max.2x35W	Max.2x60W
<b>Lamp Holder</b>	:	GU10	GU10	E27
<b>Body</b>	:	Stainless Steel	Stainless Steel	Aluminium
<b>Sizes (mm)</b>	:	A: 116 B: 93 C: 85	A: 160 B: 93 C: 85	A: 300 B: 173 C: 108

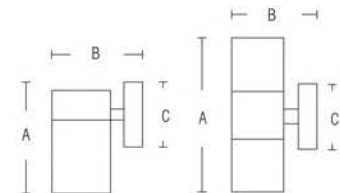



**HOROZ ELECTRIC**

Садово-парковые светильники

**PROTON**

- 85-265V / 50-60Hz
- 4200K
- Average Life: 30.000 Hrs

**BLACK**

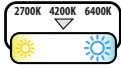

PROTON 4	PROTON 6	PROTON 8
076-039-0004	076-039-0006	076-039-0008

Power	: 4 W	6 W	8 W
Luminous Flux	: 360 lm	540 lm	720 lm
Lighting Direction	: Up&Down	Up&Down	Up&Down
Sizes (mm)	: A: 92 B: 120 C: 38	A: 95 B: 185 C: 38	A: 95 B: 220 C: 50

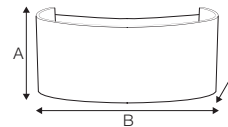



**HOROZ ELECTRIC**

Садово-парковые светильники

**SUPERB**

- 85-265V / 50-60Hz
- 4200K
- 555 lm
- Average Life: 30.000 Hrs

076 040 0015

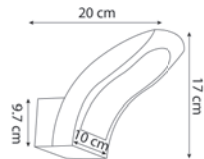
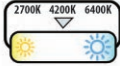

BLACK

**NEW PRODUCT**



**ANDIZ**

**NEW PRODUCT**

BLACK

WHITE

076 037 0009



- 100-240V 50-60Hz
- 4200K
- 450 lm
- Average Life: 30.000 Hrs

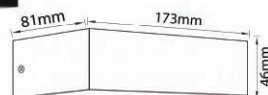

**SEKOYA**

**NEW PRODUCT**

BLACK

WHITE

076 038 0004



- 100-240V 50-60Hz
- 4200K
- 250 lm
- Average Life: 30.000 Hrs



Adjustable Beam Angle

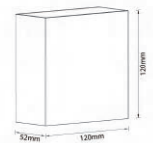

**HOROZ ELECTRIC****Садово-парковые светильники****SUGA**

- 85-265V / 50-60Hz
- 12W
- 4200K
- 1000 lm
- Срок службы 30 000 Часов

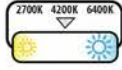
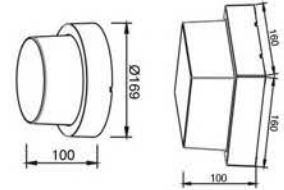
**BLACK**

SUGA-12/RO	SUGA-12/RC	SUGA-12/SO	SUGA-12/SC
076-021-0012	076-019-0012	076-022-0012	076-020-0012

Luminous Flux	:	1000 lm	700 lm	900 lm	650 lm
---------------	---	---------	--------	--------	--------

**ZEYTİN**

076 032 0012

**BLACK****BADEM**

076 028 0012

**DARK GREY****SUSAM**

076 030 0012

**DARK GREY****ILGIN**

076 029 0012

**DARK GREY**

- 100-240V / 50-60Hz
- 12W
- 4200K
- 480 lm
- Срок службы 30 000 Часов

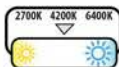
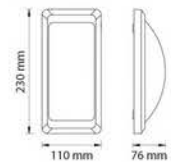

**HOROZ ELECTRIC****Садово-парковые светильники****ARENA**

076 033 0010

**NEW PRODUCT**

- 100-240V / 50-60Hz
- 750 lm
- 4200K
- Встроенный автоматический фотодатчик
- В комплекте наклейки (цифры и буквы)
- Срок службы 30 000 Часов

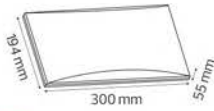
**48D****LED HOUSE NUMBER****KUKA-5**

076 031 0005

**NEW PRODUCT**

- 100-240V / 50-60Hz
- 4200K
- 290 lm
- Срок службы 30 000 Часов

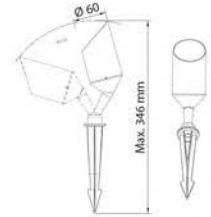
**IP67****HURMA**

076 010 0005

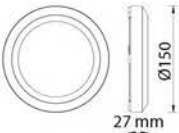
**MERSİN**

076 011 0005

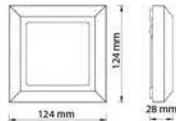
**GÜRGEN**

076 012 0005

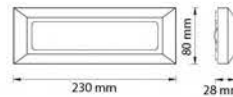
**DARK GREY**

- 100-240V / 50-60Hz
- 4200K
- 270 lm
- Срок службы 30 000 Часов

**IP65****IHLAMUR**

076 013 0002

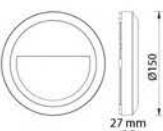
**İĞDE**

076 014 0002

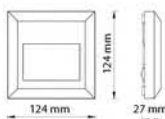
**İNCİR**

076 015 0002

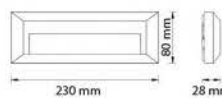
**DARK GREY**

- 100-240V / 50-60Hz
- 4200K
- 110 lm
- Срок службы 30 000 Часов

**IP65**



**HOROZ ELECTRIC**

Садово-парковые светильники

**SERVI**

076 009 0012

**BLACK****WHITE**

- 100-240V / 50-60Hz
- 4200K
- 750 lm
- Срок службы 30 000 Часов

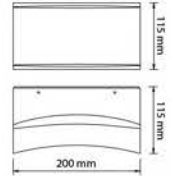
**12W****COB LED****IP65****ARDIÇ**

076 003 0006

**BLACK**

- Алюминиевый корпус
- 220-240V / 50-60Hz
- 4100K
- 385 lm
- Срок службы 30 000 Часов

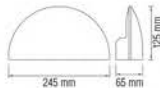
**5.5W****POWER LED****IP44****SELVI**

076 007 0004

**BLACK**

- Алюминиевый корпус
- 220-240V / 50-60Hz
- 4100K
- 35 lm
- Срок службы 30 000 Часов

**3.5W****SMD LED****IP44****MEŞE**

076 004 0006

**BLACK**

- Алюминиевый корпус
- 220-240V / 50-60Hz
- 4100K
- 420 lm
- Срок службы 30 000 Часов

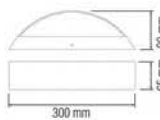
**5.5W****SMD LED****IP44****SALKIM**

076 008 0004

**BLACK**

- Алюминиевый корпус
- 220-240V / 50-60Hz
- 4100K
- 65 lm
- Срок службы 30 000 Часов

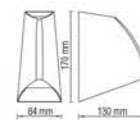
**3.5W****SMD LED****IP44****ZAKKUM**

076 005 0003

**BLACK**

- Алюминиевый корпус
- 220-240V / 50-60Hz
- 4100K
- 230 lm
- Срок службы 30 000 Часов

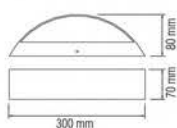
**3W****SMD LED****IP44****TAFLAN**

076 006 0006

**BLACK**

- Алюминиевый корпус
- 220-240V / 50-60Hz
- 4100K
- 200 lm
- Срок службы 30 000 Часов

**5.5W****SMD LED****IP44**



# HOGOZ ELECTRIC

## LED Светильники на солнечных батареях

### SOLARIS

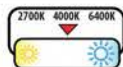

- Li-ION Battery 3.7V 2200 mAh
- 4000K
- Время зарядки: 4-6 от прямых солнечных лучей
- Срок службы 50 000 Часов

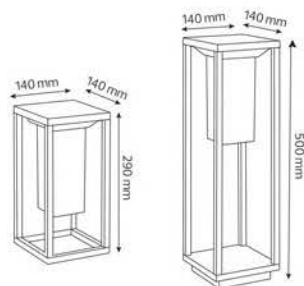

	SOLARIS-1	SOLARIS-2
	078-014-0001	078-014-0002

Power	: 2 W	2 W
Luminous Flux	: 220 lm (Strong) - 12 lm (Weak)	275 lm (Strong) - 18 lm (Weak)



## LED Светильники на солнечных батареях



### SIRIUS



WITH PIR SENSOR



- Li-ION Battery 3.7V 2200 mAh
- 4000K
- Время зарядки: 8-10 от прямых солнечных лучей
- Срок службы 50 000 Часов

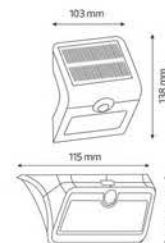

	SIRIUS-1	SIRIUS-2
	078-012-0001	078-012-0002

Power	: 1 W	2 W
Luminous Flux	: 140 lm (Strong) - 8 lm (Weak)	240 lm (Strong) - 12 lm (Weak)
Back Light	: Yes (Blue)	No





**HOROSZ ELECTRIC**

## LED Светильники на солнечных батареях

### OMNIA

078 013 0003



LED  
HOUSE  
NUMBER

- Li-ION Battery 3.7V 1800 mAh
- 4000K
- 4 lm
- Время зарядки: 4-6 от прямых солнечных лучей
- USB зарядка
- Срок службы 50 000 Часов



NEW  
PRODUCT



### VENÜS

078 001 0001



- Ni-MH AA 200 mAh 1.2V
- 6400K
- 1.5 lm
- Срок службы 50 000 Часов



### CRYSTAL

078 009 0001



- Ni-MH AA 100 mAh 1.2V
- 6400K
- 1.5 lm
- Срок службы 50 000 Часов

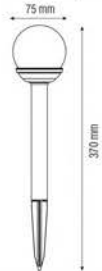

### ORBIT

078 010 0001



- Ni-MH AA 200 mAh 1.2V
- 6400K
- 1.5 lm
- Срок службы 50 000 Часов

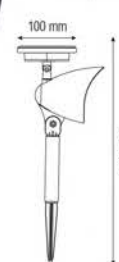

### LOTUS

078 011 0001



- Ni-MH AA 200 mAh 1.2V
- 6400K
- 1.5 lm
- Срок службы 50 000 Часов

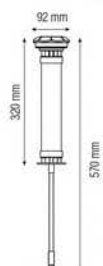

### MARS

078 002 0001



- Ni-MH AA 200 mAh 1.2V
- 6400K
- 1.5 lm
- Срок службы 50 000 Часов

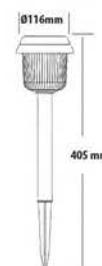



# ГОГОЗ ELECTRIC

## LED Светильники на солнечных батареях

### PLUTON

078 005 0001



- Ni-MH AA 100 mAh 1.2V
- 6400K
- 1.5 lm
- Срок службы 100 000 Часов

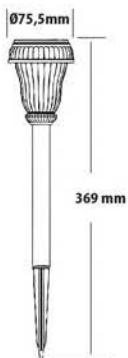

### NEPTUN

078 004 0001



- Ni-MH AA 100 mAh 1.2V
- 6400K
- 1.5 lm
- Срок службы 100 000 Часов

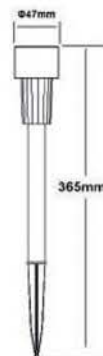

### HALLEY

078 006 0001



- Ni-MH AA 100 mAh 1.2V
- 6400K
- 1.5 lm
- Срок службы 100 000 Часов



### MAGIC

078 007 0001



- 3 Ni-MH AA 100 mAh 1.2V
- 6400K
- 9x1.5 lm
- Срок службы 100 000 Часов

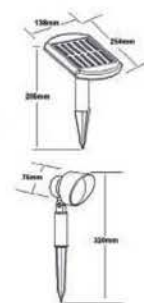

### WIZARD

078 008 0001



WITH PIR SENSOR

- 3 Ni-MH 600 mAh 1.2V
- 6400K
- 150 lm
- Срок службы 100 000 Часов





**HOROZ ELECTRIC**

## LED Встраиваемые грунтовые и лестничные светильники

**RUBY**

079 028 0002

**QUARTZ**

079 027 0002

**WHITE**

- 110-265V / 50-60Hz
- 100 lm
- 4000K
- Микроволновой датчик
- Срок службы 30 000 Часов

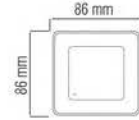

## LED Встраиваемые грунтовые и лестничные светильники



**HOROZ ELECTRIC**



**DIAMOND**

079 026 0002

**WHITE**

**BLACK**

**GOLD**

**SILVER**

- 110-265V / 50-60Hz
- 150 lm
- 4200K
- Микроволновой датчик
- Срок службы 30 000 Часов

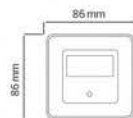

**GOLD**

079 025 0003

**WHITE**

- 220-240V / 50-60Hz
- 240 lm
- 4200K
- Инфракрасный датчик
- Срок службы 30 000 Часов



**WITH PIR SENSOR**

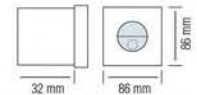



**HOROZ ELECTRIC**

# LED Встраиваемые грунтовые и лестничные светильники

**ZÜMRÜT**

079 001 0003

**YAKUT**

079 002 0003

**WHITE**

**MAT CHROME**

- 220-240V / 50-60Hz
- 86 lm
- 4000K
- Срок службы 30 000 Часов

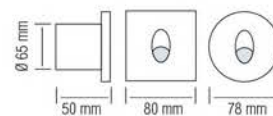

**İNCİ**

079 004 0002

**SAFİR**

079 003 0002

- 220-240V / 50-60Hz
- 75 lm
- Срок службы 50 000 Часов

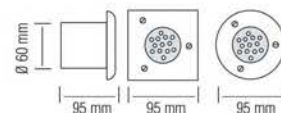

**ELMAS**

079 005 0002

**WHITE**

- 220-240V / 50-60Hz
- 198 lm
- Срок службы 50 000 Часов

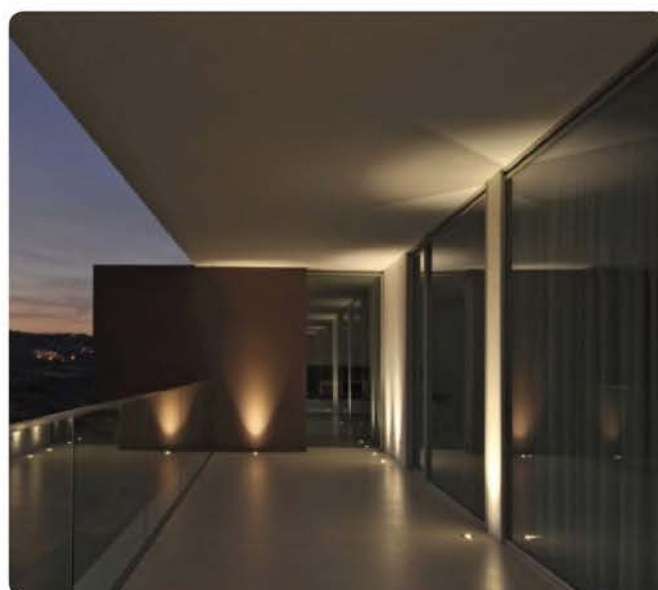
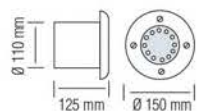

**HOROZ ELECTRIC**

## LED Встраиваемые грунтовые и лестничные светильники

- 220-240V / 50-60Hz
- Aluminium + Stainless Steel
- Average Life: 50.000 Hrs

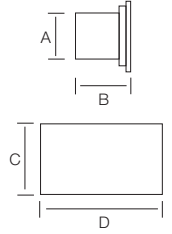
**SEDEF****OLTU****BERİL****PERLE****AMBER****PERA**

	SEDEF	PERLE	OLTU	AMBER	BERİL	PERA
	079-015-0002	079-021-0002	079-016-0002	079-022-0002	079-017-0002	079-023-0002
Power	: 1.6 W	: 1.2 W	: 1.6 W	: 1.2 W	: 1.6 W	: 1.2 W
Luminous Flux	: 90 lm	: 72 lm	: 90 lm	: 72 lm	: 90 lm	: 72 lm
Sizes (mm)	: A: 45 B: 58 C: 70 D: 170	: A: 31 B: 58 C: 45 D: 110	: A: 45 B: 58 C: 70 D: 170	: A: 31 B: 58 C: 45 D: 110	: A: 45 B: 58 C: 70 D: 170	: A: 31 B: 58 C: 45 D: 110

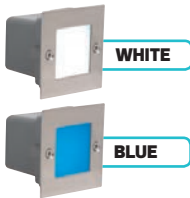
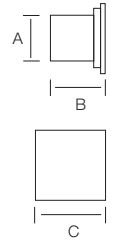

- 220-240V / 50-60Hz
- Aluminium + Stainless Steel
- Average Life: 50.000 Hrs

**MERCAN****AKİK****ONİKS****GÜMÜŞ****BRONZ****BOR**

	MERCAN	GÜMÜŞ	AKİK	BRONZ	ONİKS	BOR
	079-012-0002	079-018-0001	079-013-0002	079-019-0001	079-014-0002	079-020-0001
Power	: 1.6 W	: 0.9 W	: 1.6 W	: 0.9 W	: 1.6 W	: 0.9 W
Luminous Flux	: 90 lm	: 57 lm	: 90 lm	: 57 lm	: 90 lm	: 57 lm
Sizes (mm)	: A: 70 B: 58 C: 105	: A: 45 B: 58 C: 70	: A: 70 B: 58 C: 105	: A: 45 B: 58 C: 70	: A: 70 B: 58 C: 105	: A: 45 B: 58 C: 70

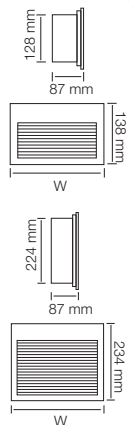

- 220-240V / 50-60Hz
- Average Life: 50.000 Hrs

**KUVARŞ****KALSİT****OPAL****KORNET****GRANİT****PIRLANTA**

	KUVARŞ	KALSİT	OPAL	KORNET	GRANİT	PIRLANTA
	079-006-0002	079-007-0002	079-008-0003	079-009-0002	079-010-0002	079-011-0003
Power	: 1.5 W	: 1.8 W	: 2.7 W	: 1.5 W	: 1.8 W	: 2.7 W
Luminous Flux	: 90 lm	: 105 lm	: 160 lm	: 90 lm	: 105 lm	: 160 lm
Width (mm)	: W: 95	: W: 140	: W: 185	: W: 95	: W: 140	: W: 185





**HOGOZ ELECTRIC**

Светодиодные ленты / Драйверы / RGB-контроллеры / Неон

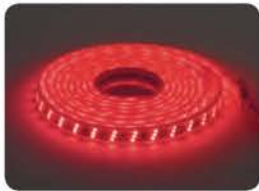

RED

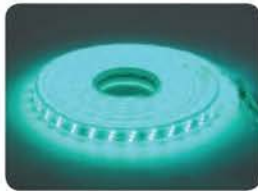

GREEN

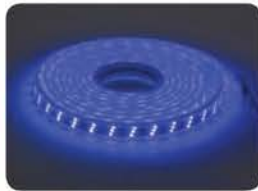

BLUE



RGB



3000K



4000K



6400K



**SINGLE CHIP**



081 009 0001

081 009 0002



**WATERPROOF**

- 220-240V / 50-60Hz
- 7W/m (RGB 12.5 W/m)
- 63.000 lm, per 164ft reel
- Срок службы 30 000 Часов
- Standart Length: 1m / 180 LED
- LED Type: 28x35 SMD
- LED View Angle: 120
- Package: 50 m / Roll
- 5 accessories



**220-240V**



Can be cut each 1meter

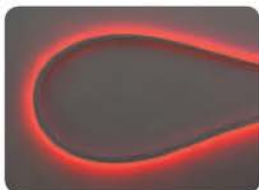
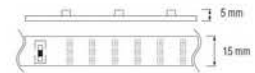

RED



GREEN

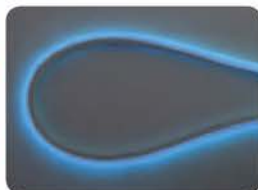

BLUE

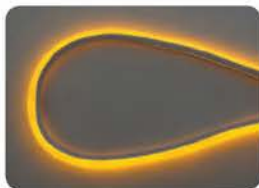

YELLOW



2700K



6400K

**NEOLED**

**WATERPROOF**

081 010 0001

**220-240V**



Can be cut each 1meter



- 220-240V / 50-60Hz
- 6.5W/m
- 264.000 lm / per 328ft. reel
- Срок службы 30 000 Часов
- Standart Length: 1m / 120 LED
- LED Type: 28x35 SMD
- LED View Angle: 120
- Package: 100m / Roll
- 5 accessories







**HOGOZ ELECTRIC**

Светодиодные ленты / Драйверы / RGB-контроллеры / Неон

**RGB RF CONTROLLER**

220-240V / 50-60Hz



**NEW PRODUCT**



VOLGA RGB RF 1	COLORADO RGB RF 1	GANJ RGB RF 1
081-004-0013	081-006-0013	081-009-0013
10 mm	12 mm	12 mm
3x1A, For Max.750W		

VOLGA RGB RF 2	COLORADO RGB RF 2	GANJ RGB RF 2
081-004-0014	081-006-0014	081-009-0014
10 mm	12 mm	12 mm
3x3A, For Max.1500W		



**SOCKET SET**

- 1 pcs 6A Socket (220V-)
- 1 pcs Connector
- 1 pcs Middle Plug
- 1 pcs End Cap
- 5 pcs Silicon Clips

**NEW PRODUCT**

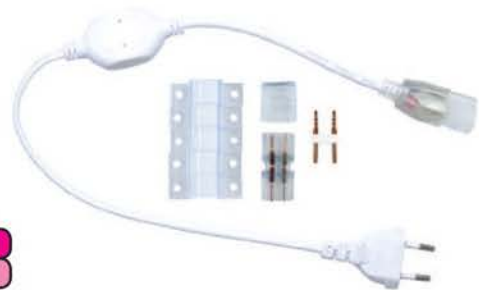

VOLGA SOCKET	COLORADO SOCKET	GANJ SOCKET	NEOLED SOCKET
081-004-0011	081-006-0011	081-009-0011	081-010-0011
8 mm	10 mm	12 mm	6 mm

**RGB SOCKET SET**

- 1 pcs 6A 8 Function Socket (220V-)
- 1 pcs Connector
- 1 pcs Middle Plug
- 1 pcs End Cap
- 5 pcs Silicon Clips

**NEW PRODUCT**



VOLGA RGB SOCKET	COLORADO RGB SOCKET	GANJ RGB SOCKET
081-004-0012	081-006-0012	081-009-0012
10 mm	12 mm	12 mm



**HOGOZ ELECTRIC**

Светодиодные ленты / Драйверы / RGB-контроллеры / Неон

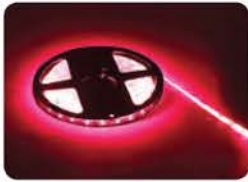

RED

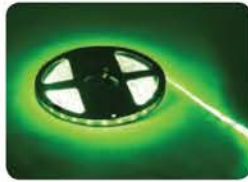

GREEN



BLUE



RGB



3000K



4200K



6400K



**SINGLE CHIP**

**REN**

081 001 0001

**REN/RGB**

081 001 0002

**12V DC**

**WATERPROOF**

- 12V DC
- Input Current: 2A (1Roll/5m)
- 24W (1 Roll/5m)
- 1.440 lm, per 16ft reel
- Срок службы 30 000 Часов
- Standart Length: 1m / 60 LED
- LED Type: 35x28 SMD
- LED View Angle: 120
- Package: 5 m / Roll
- PCB Color: White
- With 3M self-adhesive backing for easy installation



3 LEDs make a group and each group can be cut or extended in terms of the lenght of application

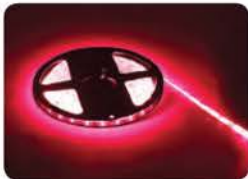
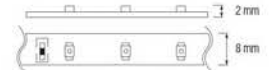

RED

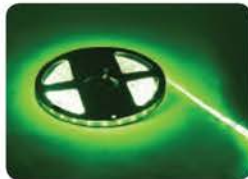

GREEN



BLUE



RGB



3000K



4200K



6400K



**SINGLE CHIP**

**NIŁ**

081 002 0001

**NIŁ/RGB**

081 002 0002

**12V DC**

**NON WATERPROOF**

- 12V DC
- Input Current: 2A (1Roll/5m)
- 24W (1 Roll/5m)
- 1.440 lm, per 16ft reel
- Срок службы 30 000 Часов
- Standart Length: 1m / 60 LED
- LED Type: 35x28 SMD
- LED View Angle: 120
- Package: 5 m / Roll
- PCB Color: White
- With 3M self-adhesive backing for easy installation



3 LEDs make a group and each group can be cut or extended in terms of the lenght of application

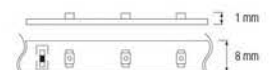



**HOGOZ ELECTRIC**

Светодиодные ленты / Драйверы / RGB-контроллеры / Неон

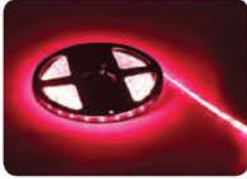

RED

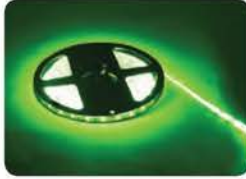

GREEN



BLUE



RGB



3000K



6400K



**THREE CHIPS**

**THAMES**

081 003 0001

**THAMES/RGB**

081 003 0002

**12V DC**

**WATERPROOF**

- 12V DC
- Input Current: 6A (1 Roll/5m)
- 72W (1 Roll/5m)
- 4.320 lm, per 16ft reel
- Срок службы 30 000 Часов
- Standart Length: 1m / 60 LED
- LED Type: 50x50 SMD
- LED View Angle: 120
- Package: 5 m / Roll
- PCB Color: White
- With 3M self-adhesive backing for easy installation



3 LEDs make a group and each group can be cut or extended in terms of the length of application

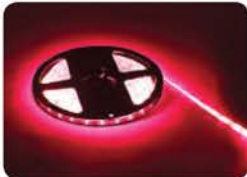
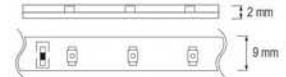

RED

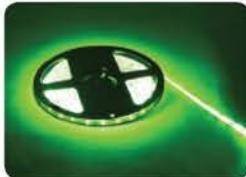

GREEN



BLUE



RGB



3000K



6400K



**THREE CHIPS**

**AMAZON**

081 005 0001

**AMAZON/RGB**

081 005 0002

**12V DC**

**NON WATERPROOF**

- 12V DC
- Input Current: 6A (1 Roll/5m)
- 72W (1 Roll/5m)
- 4.320 lm, per 16ft reel
- Срок службы 30 000 Часов
- Standart Length: 1m / 60 LED
- LED Type: 50x50 SMD
- LED View Angle: 120
- Package: 5 m / Roll
- PCB Color: White
- With 3M self-adhesive backing for easy installation



3 LEDs make a group and each group can be cut or extended in terms of the length of application

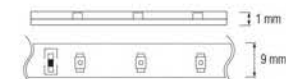

**HOGOZ ELECTRIC**

Светодиодные ленты / Драйверы / RGB-контроллеры / Неон

**VEGA**

- Input Voltage: AC 220–240V / 50–60Hz
- Output Voltage: DC 12V

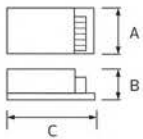

	VEGA-10	VEGA-36	VEGA-60	VEGA-100	VEGA-150	VEGA-200	VEGA-250	VEGA-360
	082-001-0010	082-001-0036	082-001-0060	082-001-0100	082-001-0150	082-001-0200	082-001-0250	082-001-0360
Output Power	10 W	36 W	60 W	100 W	150 W	200 W	250 W	360 W
Output Current	0.8A	3A	5A	8.5A	12A	17A	20.8A	30A
35x28 SMD LED Strip	2m	5m	10m	20m	30m	40m	50m	70m
50x50 SMD LED Strip	1m	1.5m	4m	6.5m	10m	13m	17m	24m
Size (mm)	A: 35 B: 22 C: 77	A: 32 B: 27 C: 140	A: 40 B: 30 C: 160	A: 40 B: 30 C: 160	A: 57 B: 42 C: 200	A: 67 B: 40 C: 220	A: 62 B: 40 C: 225	A: 62 B: 40 C: 225

**VESTA**

- Input Voltage: AC 220–240V / 50–60Hz
- Output Voltage: DC 12V

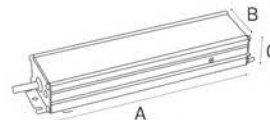
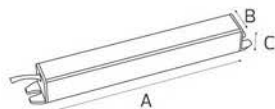
**WATERPROOF**

	VESTA-18	VESTA-25	VESTA-45	VESTA-60	VESTA-100	VESTA-150	VESTA-200
	083-001-0018	083-001-0025	083-001-0045	083-001-0060	083-001-0100	083-001-0150	083-001-0200
Output Power	18 W	25 W	45 W	60 W	100 W	150 W	200 W
Output Current	1.5 A	2A	3.75 A	5A	8.5 A	12.5A	17A
Protection Class	II	II	II	II	I	I	I
35x28 SMD LED Strip	3.5m	5m	8m	12m	20m	30m	40m
50x50 SMD LED Strip	1.2m	1.7m	2.5m	4m	6.5m	10m	13m
Size (mm)	A: 186 B: 20 C: 20	A: 186 B: 20 C: 20	A: 307 B: 20 C: 20	A: 307 B: 20 C: 20	A: 220 B: 51 C: 32	A: 230 B: 65 C: 32	A: 252 B: 70 C: 45



**HOGOZ ELECTRIC****Драйверы / Гирлянды**

100 001 0072

**RGB Controller 2A**

- Input Voltage: DC 12V - 24V
- Output Voltage: DC 12V - 24V
- Output Power: 72W
- Output Current: 2A/Each Color

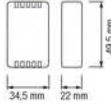

For Max. 15m 35x28 SMD LED Strip  
For Max. 5m 50x50 SMD LED Strip



100 002 0144

**RGB Controller 4A**

- Input Voltage: DC 12V - 24V
- Output Voltage: DC 12V - 24V
- Output Power: 144W
- Output Current: 4A/Each Color

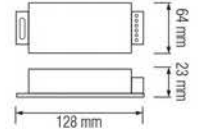

For Max. 30m 35x28 SMD LED Strip  
For Max. 10m 50x50 SMD LED Strip

**AMPLIFIER**

- Input Voltage: DC 12V - 24V
- Output Voltage: DC 12V - 24V

	AMPLIFIER-12A	AMPLIFIER-24A
	101-001-0144	101-001-0288

Output Power	: 144 W	: 288 W
Output Current	: 4A/Each Color	: 8A/Each Color
35x28 RGB LED Strip	: 30 Meters with 60Leds/Meter	: 60 Meters with 60Leds/Meter
50x50 RGB LED Strip	: 10 Meters with 60Leds/Meter	: 20 Meters with 60Leds/Meter

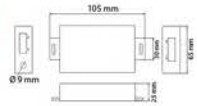
**HOGOZ ELECTRIC****Драйверы / Гирлянды****MONTANA**

- 4.5V DC
- 4W/10 m
- Срок службы 25 000 Часов
- Standart Length: 1 m / 10 LED
- Package: 10 m / Roll

080 001 0004

**MONTANA-D4**

080 001 0001

- 100-240V / 50-60Hz
- 16W/40 m

**MONTANA-D10**

080 001 0002

- 100-240V / 50-60Hz
- 40W/100 m

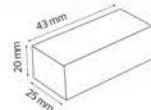

**HOGOZ ELECTRIC****LED аварийные светильники и фонари****HOGOZ ELECTRIC****LED Аварийные  
светильники  
и фонари**

084 022 0010

**ROMARIO****RECHARGEABLE****SOLAR**

- 220-240V / 50-60Hz
- 10W. 360 lm
- 4V 1600mAh Перезаряжаемый герметичный кислотный аккумулятор
- Время работы: 1 час / сильный свет  
25 часов / слабый свет
- Срок службы 30 000 Часов

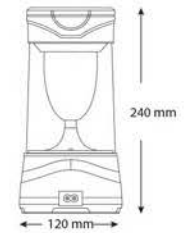
**BEST**

- 220-240V / 50-60Hz
- Срок службы 30 000 Часов
- Время работы: 1 час / сильный свет  
4 часов / слабый свет

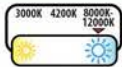

	BEST-1	BEST-3	BEST-5
	084-024-0001	084-024-0003	084-024-0005

Power	: 1 W	3 W	5 W
Luminous Flux	: 70 lm	120 lm	210 lm
Battery	: 4V 0.4Ah Sealed-Acid	4V 0.9Ah Sealed-Acid	4V 1.6Ah Sealed-Acid
Sizes (mm)	: A: 51 B: 200	A: 65 B: 220	A: 85 B: 240

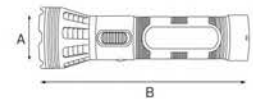

OFF-1-2

**PELE**

- 220-240V / 50-60Hz
- Срок службы 30 000 Часов
- Время работы: 1 час / сильный свет  
4 часов / слабый свет

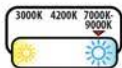

	PELE-1	PELE-2	PELE-3
	084-006-0001	084-006-0002	084-006-0003

Power	: 0.5 W	1 W	3 W
Luminous Flux	: 30 lm	73 lm	120 lm
Battery	: 4V 200mAh Sealed-Acid	4V 400mAh Sealed-Acid	4V 900mAh Sealed-Acid
Sizes (mm)	: A: 65 B: 220	A: 51 B: 155	A: 65 B: 170

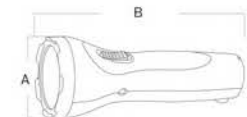

OFF-1-2

**HOROSZ ELECTRIC****LED аварийные светильники и фонари****MARADONA**

- 220-240V / 50-60Hz
- Срок службы 30 000 Часов

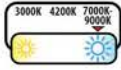
**MARADONA-2****084-003-0002**

Power	:	<b>5 W</b>
Luminous Flux	:	350 lm
Battery	:	4V 6Ah Sealed-Acid
Duration Time	:	4 час / сильный свет 16 часов / слабый свет

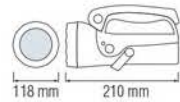
**RECHARGEABLE****LED TORCH**

OFF-1-2

**PUSKAS**

- 220-240V / 50-60Hz
- Срок службы 30 000 Часов

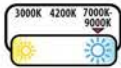
**PUSKAS-2****084-005-0002****PUSKAS-3****084-005-0003**

Power	:	<b>0.5 W</b>	<b>0.9 W</b>
Luminous Flux	:	25 lm	45 lm
Battery	:	4V 0.4Ah Sealed-Acid	4V 0.9Ah Sealed-Acid
Duration Time	:	4 Hours	5 Hours
Sizes (mm)	:	A: 75 B: 195	A: 100 B: 210

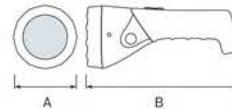
**RECHARGEABLE****LED TORCH**

ON-OFF

**BECKHAM**

- 220-240V / 50-60Hz
- Срок службы 30 000 Часов

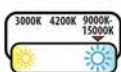
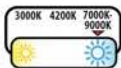
**RECHARGEABLE****LED HEADLIGHT****BECKHAM-1****084-007-0001****BECKHAM-3****084-007-0003****BECKHAM-4****084-007-0004**

Power	:	<b>1 W (Power LED)</b>	<b>3 W (Power LED)</b>	<b>0.9 W (LED)</b>
Luminous Flux	:	7000-9000K	7000-9000K	9000-15000K
Battery	:	4V 400mAh Sealed-Acid	4V 900mAh Sealed-Acid	4V 900mAh Sealed-Acid
Duration Time	:	1 час / сильный свет 4 часа / слабый свет	1 час / сильный свет 4 часа / слабый свет	1 час / сильный свет 4 часа / слабый свет
Beam Distance	:	20m	30m	20m
Size (mm)	:	A: 70 B: 81 C: 98	A: 85 B: 92 C: 96	A: 85 B: 92 C: 96



1-OFF-2



# HOROZ ELECTRIC

## LED аварийные светильники и фонари

### MESSI

- 220-240V / 50-60Hz or 6V DC
- Срок службы 30 000 Часов

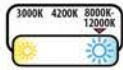

	MESSI-9	MESSI-15	MESSI-23
	084-030-0009	084-030-0015	084-030-0023

Power	: 9 W	15 W	23 W
Luminous Flux	: 280 lm-38 lm	420 lm-70 lm	600 lm-100 lm
Battery	: 4V 1.6Ah Sealed-Acid	2x4V 1.6Ah Sealed-Acid	2x4V 1.6Ah Sealed-Acid
Duration Time	: 3-20 Hours	3-15 Hours	2-10 Hours
Size (mm)	: A: 250 B: 50 C: 50	A: 350 B: 50 C: 50	A: 450 B: 50 C: 50



- RECHARGEABLE
- EMERGENCY
- LANTERN

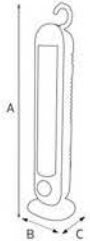

### MALDINI

- 220-240V / 50-60Hz
- Срок службы 30 000 Часов

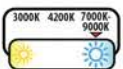

	MALDINI-2	MALDINI-3
	084-014-0002	084-014-0003

Power	: 13 W	16 W
Luminous Flux	: 330 lm	410 lm
Battery	: 2x4V 0.9Ah Sealed-Acid	2x4V 0.9Ah Sealed-Acid
Duration Time	: 3 Hours	3 Hours
Size (mm)	: A: 245 B: 75 C: 45	A: 325 B: 75 C: 45



- EMERGENCY EXIT
- SAFETY EMERGENCY
- LANTERN

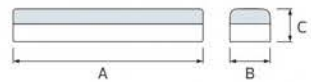

### WENGER

- 220-240V / 50-60Hz
- 560 lm
- 4V 3Ah Rechargeable Sealed-Acid Battery
- Время работы: Режим 1: 1 час, Режим 2: 2 час
- Срок службы 30 000 Часов

084 025 0012

- RECHARGEABLE
- EMERGENCY
- LANTERN



1-OFF-2

### MÜLLER

084 018 0001

- RECHARGEABLE
- LED LAMP
- E27

- 220-240V / 50-60Hz
- 10x1500 MCD 110° Bright LED Light
- 50 lm
- 4V 0.9Ah Кислотная аккумуляторная батарея
- Время работы: 6 часов
- Автоматическое включение при отсутствии напряжения
- Пост. / Перемен. ток
- Срок службы 30 000 Часов



ON-OFF

### ZOFF

084 019 0001

- EXIT & SAFETY LAMP
- LED LAMP

- 220-240V / 50-60Hz
- 50 lm
- 1.2V 600mAh Rechargeable Ni-Cd Battery
- Срок службы 10 000 Часов
- Время работы: 90 минут

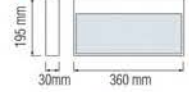

### ROBSON

084 020 0002

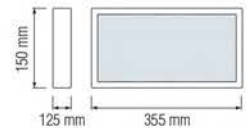

- EMERGENCY
- EXIT & SAFETY
- LED LAMP

- 220-240V / 50-60Hz
- 100 lm
- 1.2V 350mAh Rechargeable Ni-Cd Battery
- Срок службы 20 000 Часов
- Время работы: 120 минут





**HOROZ ELECTRIC**

Детекторы / Датчики управления светом /  
Таймеры / Беспроводные переключатели

**Light Control Photosensor****FLASH**

- Operation Voltage: 220-240V / 50-60Hz
- Ambient Light: <math>< 5-15 \text{ Lux}</math>
- Load Power: 1000W (6A)

089 001 0001

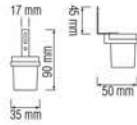
**Light Control Photosensor****FLEX**

- Operation Voltage: 220-240V / 50-60Hz
- Ambient Light: <math>< 50 \text{ Lux}</math>
- Load Power: 1200W (10A)

089 001 0002

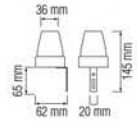
**Light Control Photosensor****LUXOR**

- Operation Voltage: 220-240V / 50-60Hz
- Ambient Light: <math>< 50 \text{ Lux}</math>
- Load Power: 2700W (25A)

089 001 0003

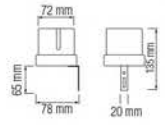
**HOROZ ELECTRIC**

Детекторы / Датчики  
управления / Таймеры /  
Беспроводные  
переключатели

**TUCSON**

088 001 0009



- Detection Source: 220-240V / AC
- Power Frequency: 50/60Hz
- Rated Load: Max. 800W
- Detection Distance: 12m Max. (<math>< 24^{\circ}\text{C}</math>)
- Time Delay: Min. 10sec + 3sec Max. 15min + 2min
- Ambient Light: <math>< 3-2000 \text{ LUX}</math> (adjustable)
- Installation Height: 1.8-2.5m
- Detection Motion Speed: 0.6-1.5m/s

**MEGANE**

088 001 0008



- Operation Voltage: 220-240V / 50-60Hz
- Detection Distance: 12 m Max. (<math>< 24^{\circ}\text{C}</math>)
- Time-delay: Min. 10 sec + 3 sec Max. 7 min + 2 min
- Ambient Light: <math>< 3 - 2000 \text{ Lux}</math> (adjustable)
- Rated Load: Max. 1200W
- Detection Motion Speed: 0.6-1.5 m/s

**CORONA**

088 001 0002



- Operation Voltage: 220-240V / 50-60Hz
- Detection Distance: 8 + 1m Max. (<math>< 24^{\circ}\text{C}</math>)
- Time-delay: 5 sec - 10+2 min.
- Ambient Light: <math>< 10 \text{ Lux} - 2000 \text{ Lux}</math>
- Rated Load: Max. 1000W

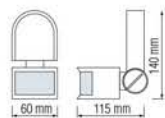

WHITE

BLACK

**LINEA**

088 001 0003



- Operation Voltage: 220-240V / 50-60Hz
- Detection Distance: 8 + 2 m Max. (<math>< 24^{\circ}\text{C}</math>)
- Time-delay: 5 sec - 8+2 min.
- Ambient Light: <math>< 10 \text{ Lux} - 2000 \text{ Lux}</math>
- Rated Load: Max. 1000W

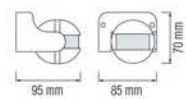

WHITE

BLACK

## FOCUS

088 001 0001

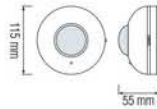

### Specification

- Operation Voltage: 220-240V / 50-60Hz
- Rated Load: Max. 1000W
- Detection Distance: 8 ± 1m Max. (-24°C)
- Time-delay: 5 sec - 10±2 min.
- Ambient Light: < 10Lux - 2000Lux

WHITE

BLACK



## MONDEO

088 001 0010

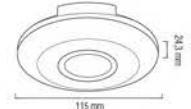

### Specification

- Detection Range: 360°
- Detection Source: 220-240V / AC
- Power Frequency: 50/60Hz
- Rated Load: Max. 800W
- Detection Distance: 6m Max. (-24°C)
- Time Delay: Min. 10sec ± 3sec Max. 15min ± 2min
- Ambient Light: < 3-2000LUX (adjustable)
- Installation Height: 2.2-4m
- Detection Motion Speed: 0.6-1.5m/s



## ROVER

088 001 0011

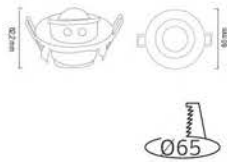

### Specification

- Detection Angle: 360°
- Detection Source: 220-240V / AC
- Power Frequency: 50/60Hz
- Rated Load: Max. 800W
- Detection Distance: 6m Max. (-24°C)
- Time Delay: Min. 10sec ± 3sec Max. 15min ± 2min
- Ambient Light: < 3-2000LUX (adjustable)
- Installation Height: 2.2-4m
- Detection Motion Speed: 0.6-1.5m/s



## CORSA

088 001 0006

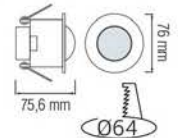

### Specification

- Operation Voltage: 220-240V / 50-60Hz AC
- Rated Load: Max. 1200W
- Detection Distance: 6m Max. (-24°C)
- Time-delay: 10s to 7 min (adjustable)
- Ambient Light: 3Lux / 2000Lux (adjustable)
- Detection Motion Speed: 0.6-1.5m/s
- Installation Height: 2.2-4m



## POLO

088 001 0007

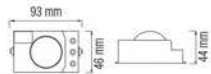

### Specification

- Operation Voltage: 220-240V / 50-60Hz
- Detection Distance: 1-8 m (radius) adjustable
- Time-delay: Min. 10 sec ± 3 sec. Max. 12 min ± 1 min
- Ambient Light: < 3 - 2000Lux (adjustable)
- Rated Load: Max 1200W
- Detection Motion Speed: 0.6-1.5 m/s



## SMART

088 001 0005

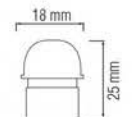

### Specification

- Operation Voltage: 220-240V / 50-60Hz AC
- Rated Load: Max. 1200W
- Detection Distance: 6m Max. (-24°C)
- Time-delay: 10s to 7 min (adjustable)
- Ambient Light: 10Lux / 2000Lux (choice)



Detection is possible to go through doors, panes of glass or thin walls

**HOROZ ELECTRIC**

# Детекторы / Датчики управления светом / Таймеры / Беспроводные переключатели

## CONTROLLER

**Wireless Lighting Controller Switch**

- Working voltage: AC 180-240V 50Hz
- Operation Range: 30m-60m in 360 degree (in open area)
- Tungsten filament lamp: 1000W
- Energy saving lamp/LED: 300W
- Working voltage: 12V(A23 alkaline battery)

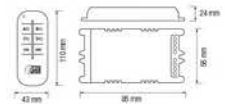
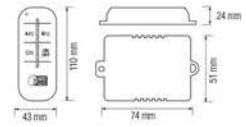
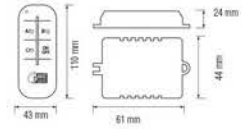
**CONTROLLER-1**

105-001-0001

1 Channel

**CONTROLLER-2**

105-001-0002

2 Channels

**CONTROLLER-3**

105-001-0003

3 Channels

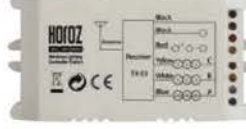
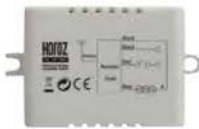

## TIMER

- Working voltage: AC 220-240V 50Hz
- Power: 3500W
- Current: 16A

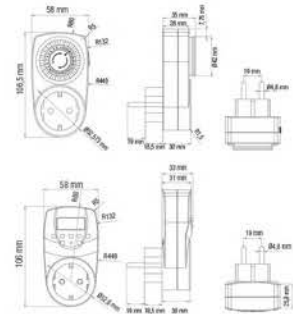

	TIMER-1	TIMER-2	TIMER-3
	108-001-0001	108-002-0001	108-003-0001

Type	Mechanical Daily	Digital Weekly	Mechanical Daily
On/Off Programs	24	20	48
Minimum Setting	30 Minutes	1 Minute	15 Minutes
Power Reserve	No	Yes	Yes

## AXIS

113 001 0001

- Working Voltage: 250V-
- Power: Max.3680W
- Current: 16A
- Child Protection Shutter
- Working signal indicator
- USB O/P: DC 5V, Max 2.1A

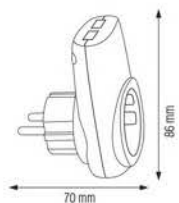
**PLUG IN SWITCH****2 X USB CHARGING SOCKET**



**HOROZ ELECTRIC**

Диммеры / Выключатели / Розетки



**HOROZ ELECTRIC**

Диммеры /  
Выключатели / Розетки



**HORIZON**

112 006 0001

- 250V-
- DIMMER (10A)
- 400W (Incandescent)
- 300W (LED)

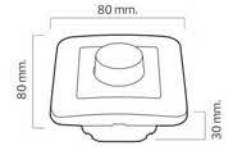

**ATOM**

■ 250V-

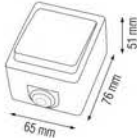

112 100 0004

■ ONE WAY SWITCH (10A)



112 100 0007

■ TWO WAY SWITCH (10A)

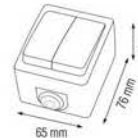

112 100 0006

■ 2-GANG ONE WAY SWITCH (10A)

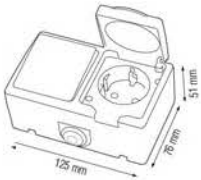

112 100 0003

■ 1-GANG GROUNDED SOCKET (16A)  
■ 1-GANG ONE WAY SWITCH (10A)

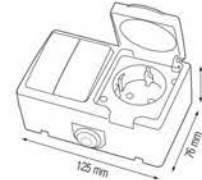

112 100 0005

■ 1-GANG GROUNDED SOCKET (16A)  
■ 2-GANG ONE WAY SWITCH (10A)

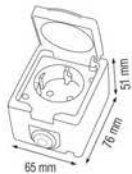

112 100 0001

■ GROUNDED SOCKET (16A)

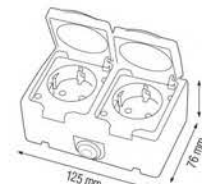

112 100 0002

■ 2-GANG GROUNDED SOCKET (16A)





**EVA**

■ 250V~

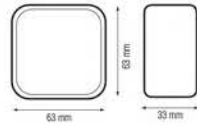

112 001 0001 ■ ONE WAY SWITCH (10A)

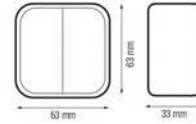

112 001 0003 ■ 2-GANG ONE WAY SWITCH (10A)

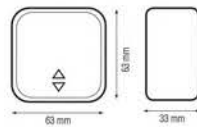

112 001 0002 ■ TWO WAY SWITCH (10A)

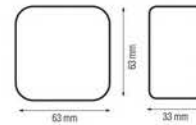

112 001 0004 ■ PUSH BUTTON (10A)

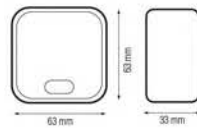

112 002 0001 ■ ILLUMINATED ONE WAY SWITCH (10A)

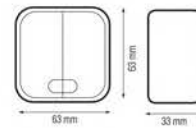

112 002 0002 ■ 2-GANG ILLUMINATED ONE WAY SWITCH (10A)

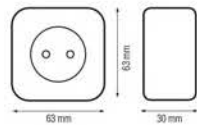

112 003 0001 ■ SOCKET (16A)

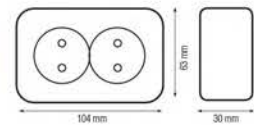

112 003 0002 ■ 2-GANG SOCKET (16A)

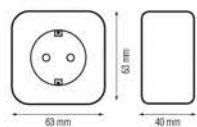

112 004 0001 ■ GROUNDED SOCKET (16A)

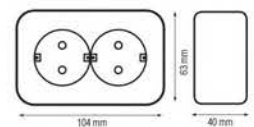

112 004 0002 ■ 2-GANG GROUNDED SOCKET (16A)





**HOGOZ ELECTRIC**

Оборудование для управления и защиты электродвигателей



**HOGOZ ELECTRIC**

Оборудование  
для управления и защиты  
электродвигателей



**SAFE**

**Автомат защиты двигателя**

**SAFE**

114 008 0001

**Бокс автомата защиты двигателя**

■ Для товаров с артикулом: 114-006-0610 и 114-006-1625



**NEW  
PRODUCT**



	114-006-0610	114-006-1625	114-006-2540	114-006-4063
Rated Current (A) :	<b>6-10A</b>	<b>16-25A</b>	<b>25-40A</b>	<b>40-63A</b>
Motor Power (kW) :	4kW	11kW	18,5kW	30kW
Poles :	3 Pole	3 Pole	3 Pole	3 Pole
Type :	<b>AC-3</b>	<b>AC-3</b>	<b>AC-3</b>	<b>AC-3</b>
Rated voltage(V) :	400V	400V	400V	400V
Sizes (mm) :	A: 89 B: 44,5 C:66	A: 89 B: 44,5 C:66	A: 121 B: 61,5 C:105	A: 121 B: 61,5 C:105

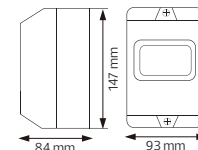
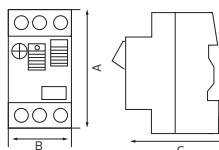

**SAFE**

## Контактор



	114-005-0009	114-005-0012	114-005-0018	114-005-0025	114-005-0032	114-005-0040	114-005-0050	114-005-0065
Rated Current (A)	9A	12A	18A	25A	32A	40A	50A	65A
Poles	3 Main + 1NO	3 Main + 1NO	3 Main + 1NO	3 Main + 1NO	3 Main + 1NO	3 Main + 1NO	3 Main + 1NO	3 Main + 1NO
е р у Т	AC-3	AC-3	AC-3	AC-3	AC-3	AC-3	AC-3	AC-3
Motor Power (kW)	4kW	5,5kW	7,5kW	11kW	15kW	18,5kW	22kW	30kW
Rated voltage(V)	400V	400V	400V	400V	400V	400V	400V	400V
Sizes (mm)	A:47B:76C:82	A:47B:76C:82	A:47B:76C:87	A:57B:86C:95	A:57B:86C:100	A:77B:129C:116	A:77B:129C:116	A:77B:129C:116

	114-005-1009	114-005-1012	114-005-1018	114-005-1025	114-005-1032	114-005-1040	114-005-1050	114-005-1065
Rated Current (A)	9A	12A	18A	25A	32A	40A	50A	65A
Poles	3 Main + 1NC	3 Main + 1NC	3 Main + 1NC	3 Main + 1NC	3 Main + 1NC	3 Main + 1NC	3 Main + 1NC	3 Main + 1NC
е р у Т	AC-3	AC-3	AC-3	AC-3	AC-3	AC-3	AC-3	AC-3
Motor Power (kW)	4kW	5,5kW	7,5kW	11kW	15kW	18,5kW	22kW	30kW
Rated voltage(V)	400V	400V	400V	400V	400V	400V	400V	400V
Sizes (mm)	A:47B:76C:82	A:47B:76C:82	A:47B:76C:87	A:57B:86C:95	A:57B:86C:100	A:77B:129C:116	A:77B:129C:116	A:77B:129C:116

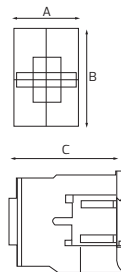

**SAFE**

## Тепловое реле



	114-007-0001	114-007-0002	114-007-0003	114-007-0004	114-007-0005	114-007-0006	114-007-0007
Rated Current (A)	0,63-1A	1-1,6A	2,5-4A	4-6A	7-10A	12-18A	17-25A
Poles	3 Main + CN1+ ON1	3 Main + CN1+ ON1	3 Main + CN1+ ON1	3 Main + CN1+ ON1	3 Main + CN1+ ON1	3 Main + CN1+ ON1	3 Main + CN1+ ON1
Rated voltage(V)	660V	660V	660V	660V	660V	660V	660V

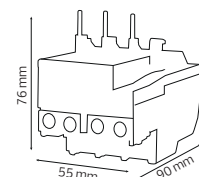

## SAFE

### Модульные автоматические выключатели

Номинальная отключающая способность при коротком замыкании: 4,5 кА



	114-001-1006	114-001-1010	114-001-1016	114-001-1020	114-001-1025	114-001-1032	114-001-1040	114-002-1002	114-002-1004	114-002-1050	114-002-1063
Rated Current	6A	10A	16A	20A	25A	32A	40A	2A	4A	50A	63A
Poles	1	1	1	1	1	1	1	1	1	1	1
Instantaneous tripping type	B	B	B	B	B	B	B	C	C	C	C
Rated working voltage	230V/400V	230V/400V	230V/400V	230V/400V	230V/400V	230V/400V	230V/400V	230V/400V	230V/400V	230V/400V	230V/400V
Width	17.5 mm	17.5 mm	17.5 mm	17.5 mm	17.5 mm	17.5 mm	17.5 mm	17.5 mm	17.5 mm	17.5 mm	17.5 mm

	114-002-2006	114-002-2010	114-002-2016	114-002-2020	114-002-2025	114-002-2032	114-002-2040	114-002-2050	114-002-2063
Rated Current	6A	10A	16A	20A	25A	32A	40A	50A	63A
Poles	2	2	2	2	2	2	2	2	2
Instantaneous tripping type	C	C	C	C	C	C	C	C	C
Rated working voltage	400V	400V	400V	400V	400V	400V	400V	400V	400V
Width	35 mm	35 mm	35 mm	35 mm	35 mm	35 mm	35 mm	35 mm	35 mm



	114-002-3006	114-002-3010	114-002-3016	114-002-3020	114-002-3025	114-002-3032	114-002-3040	114-002-3050	114-002-3063	114-002-3080	114-002-3100
Rated Current	6A	10A	16A	20A	25A	32A	40A	50A	63A	80A	100A
Poles	3	3	3	3	3	3	3	3	3	3	3
Instantaneous tripping type	C	C	C	C	C	C	C	C	C	C	C
Rated working voltage	400V	400V	400V	400V	400V	400V	400V	400V	400V	400V	400V
Width	52.5 mm	52.5 mm	52.5 mm	52.5 mm	52.5 mm	52.5 mm	52.5 mm	52.5 mm	52.5 mm	52.5 mm	52.5 mm

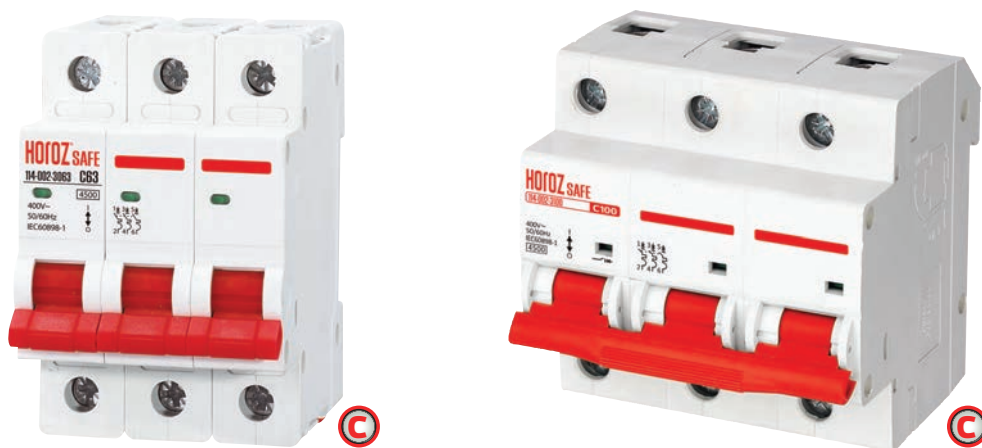
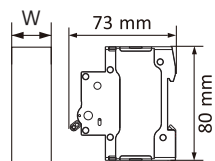





**SAFE**

**Устройство защиты от дифференциальных токов**



	114-003-2025	114-003-2040	114-003-4025	114-003-4040	114-003-4063	114-003-4080	114-003-4100
Rated Current (A)	25A	40A	25A	40A	63A	80A	100A
Poles	2 Pole	2 Pole	4 Pole	4 Pole	4 Pole	4 Pole	4 Pole
Instantaneous tripping type	AC	AC	AC	AC	AC	AC	AC
Rated short-circuit breaking capacity (kA)	4.5kA	4.5kA	4.5kA	4.5kA	4.5kA	4.5kA	4.5kA
Rated working voltage(V)	230V	230V	400V	400V	400V	400V	400V
Rated Residual Current(mA)	30	30	30	30	30	30	30
Sizes (mm)	A: 35 B: 80 C: 73	A: 35 B: 80 C: 73	A: 70 B: 80 C: 73	A: 70 B: 80 C: 73	A: 70 B: 80 C: 73	A: 72 B: 81 C: 74	A: 72 B: 81 C: 74

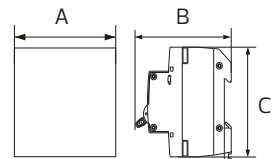

**SAFE**

**Силовые автоматические выключатели в литом корпусе**

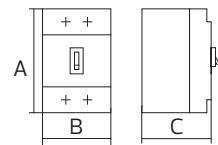

	114-004-3040	114-004-3050	114-004-3063	114-004-3100	114-004-3125	114-004-3160	114-004-3200	114-004-3250	114-004-3400	114-004-3630
Rated Current (A)	40A	50A	63A	100A	125A	160A	200A	250A	400A	630A
Poles	3 Pole	3 Pole	3 Pole	3 Pole	3 Pole	3 Pole	3 Pole	3 Pole	3 Pole	3 Pole
Instantaneous tripping type	C	C	C	C	C	C	C	C	C	C
Rated short-circuit breaking capacity (kA)	20kA	20kA	20kA	35kA	35kA	35kA	35kA	35kA	35kA	35kA
Rated working voltage(V)	400V	400V	400V	400V	400V	400V	400V	400V	400V	400V
Sizes (mm)	A: 135 B: 78 C: 74	A: 135 B: 78 C: 74	A: 135 B: 78 C: 74	A: 150 B: 92 C: 69	A: 150 B: 92 C: 69	A: 165 B: 101 C: 86	A: 165 B: 101 C: 86	A: 165 B: 101 C: 86	A: 257 B: 150 C: 106.5	A: 270 B: 182 C: 110



**HOGOZ**

**ELECTRIC**

Патроны



**HOGOZ**

**ELECTRIC**

Патроны



094 004 0001

10 cm.

20 cm.

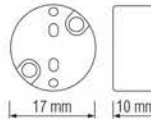

094 004 0002

15 cm.

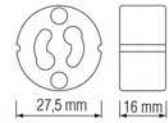

094 001 0001

**BAKELITE**

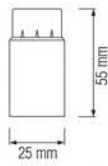

094 001 0002

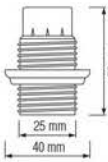

094 001 0003

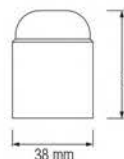

094 001 0004

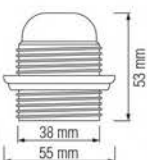

094 002 0001

**PLASTIC**

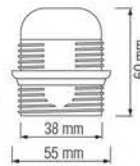

094 002 0002

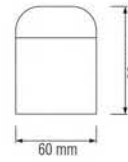

094 002 0003

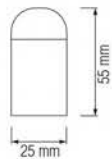

094 002 0004

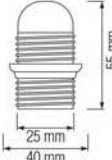

094 003 0001

**PORCELAIN**

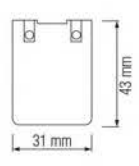

094 003 0002

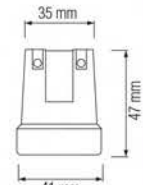

094 003 0003

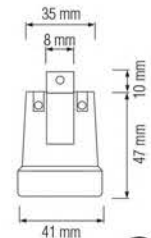

094 003 0004

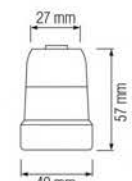



# HOGOZ ELECTRIC

## Стартеры / Клипсы / Кабель / Изолента

### Starter S10

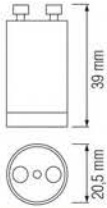

	S2	S10
220-240V SINGLE :	4-22W	4-65W
220-240V SERIES :	4-22W	-
110-130V SINGLE :	4-22W	-

### TRANSFORMER

- 220-240V / 50-60Hz
- 12V AC

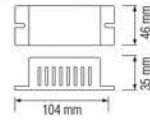

	TRANSFORMER-60	TRANSFORMER-105	TRANSFORMER-150
	093-001-0060	093-001-0105	093-001-0150
Power :	60 W	105 W	150 W



# HOGOZ ELECTRIC

## Стартеры / Клипсы / Кабель / Изолента



### ADHESIVE TAPE

- WHITE
- YELLOW
- RED
- BLUE
- GREEN
- BLACK
- GREEN - YELLOW



### NAIL CABLE CLIP



CIRCLE	NAIL
4 mm	1.7 x 15
5 mm	1.7 x 15
6 mm	1.7 x 17
7 mm	1.8 x 19
8 mm	1.9 x 21
9 mm	2.0 x 22
10 mm	2.05 x 25
12 mm	2.05 x 27
14 mm	2.4 x 32
16 mm	2.5 x 35
18 mm	2.5 x 37
22 mm	2.8 x 48

### CABLE TIE



2,5*100	7,2*300
2,5*150	7,2*350
2,5*200	7,2*400
3,6*150	7,2*450
3,6*200	9*550
3,6*250	9*650
3,6*280	9*750
3,6*300	9*1020
3,6*370	
4,8*200	
4,8*250	
4,8*300	
4,8*350	
4,8*370	
4,8*400	

### RG6

COAXIAL CABLE  
100m ROLL



6,8 PVC	64x0,12 AL. BRAIDING	AL. FOIL BONDED	4,8 FPE	1,02 CCS
---------	-------------------------	--------------------	---------	----------

### UTP

NETWORK CABLE  
305m ROLL



UTP Cat5e



UTP Cat6

## IP 68 CONNECTOR

- 250V- / 16A
- Wire Range: 0.5 - 2.5 mm<sup>2</sup>
- Cable Diameter: 6.5 to 11 mm
- Screwless 3 Pin Connection



IP 68 CONNECTOR-1	IP 68 CONNECTOR-2
106-004-0001	106-004-0002

Pole :	1 Pole	2 Poles
--------	--------	---------

## SLIM CONNECTOR

- 450V-
- Max. 32A
- Wire Range: 0.2 - 4 mm<sup>2</sup>
- Transparent

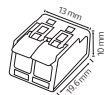

SLIM CONNECTOR-2	SLIM CONNECTOR-3	SLIM CONNECTOR-5
103-002-0002	103-002-0003	103-002-0005

Pole :	2 Poles	3 Poles	5 Poles
--------	---------	---------	---------

## CONNECTOR

- 400V/4kV-
- Max. 32A
- Wire Range: 0.08 - 4 mm<sup>2</sup>
- Spring Clamping 28-10AWG

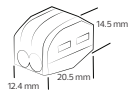

CONNECTOR-2	CONNECTOR-3	CONNECTOR-5
103-001-0002	103-001-0003	103-001-0005

Pole :	2 Poles	3 Poles	5 Poles
--------	---------	---------	---------



## WIRE SPRING

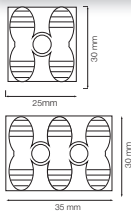

WIRE SPRING-2/1.5	WIRE SPRING-2/2.5	WIRE SPRING-2/6	WIRE SPRING-3/1.5	WIRE SPRING-3/2.5	WIRE SPRING-3/6
106-002-0015	106-002-0025	106-002-0060	106-003-0015	106-003-0025	106-003-0060

Pole :	2 Poles	2 Poles	2 Poles	3 Poles	3 Poles	3 Poles
Cable Diameter :	0.2-1.5 mm <sup>2</sup>	0.5-2.5 mm <sup>2</sup>	1.5-6.0 mm <sup>2</sup>	0.2-1.5 mm <sup>2</sup>	0.5-2.5 mm <sup>2</sup>	1.5-6.0 mm <sup>2</sup>
Current / Voltage :	5A/380V	10A/380V	25A/380V	5A/380V	10A/380V	25A/380V

## TERMINAL BLOCK

- 60 A, 25 mm<sup>2</sup>
- 30 A, 16 mm<sup>2</sup>
- 10 A, 10 mm<sup>2</sup>
- 5 A, 6 mm<sup>2</sup>
- 3 A, 4 mm<sup>2</sup>



## REEL

- 230V-/50-60Hz
- Max. 3000W
- Max. 13.04A
- 3x1.5 mm<sup>2</sup>
- 4 Sockets
- Overload Protection

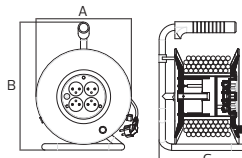

REEL-15	REEL-25	REEL-50	EMPTY-25
104-006-0015	104-006-0025	104-006-0050	104-007-0025

Cable Length :	15 Meters	25 Meters	50 Meters	Max. 25 Meters
Sizes (mm) :	A: 200 B: 260 C: 150	A: 215 B: 314 C: 170	A: 265 B: 345 C: 210	A: 230 B: 310 C: 195





Произведено в Турции

■ ■ ■ KaçmazGrup

İkili Two  
 Üçlü Three  
 Dörtlü Four  
 Altılı Six

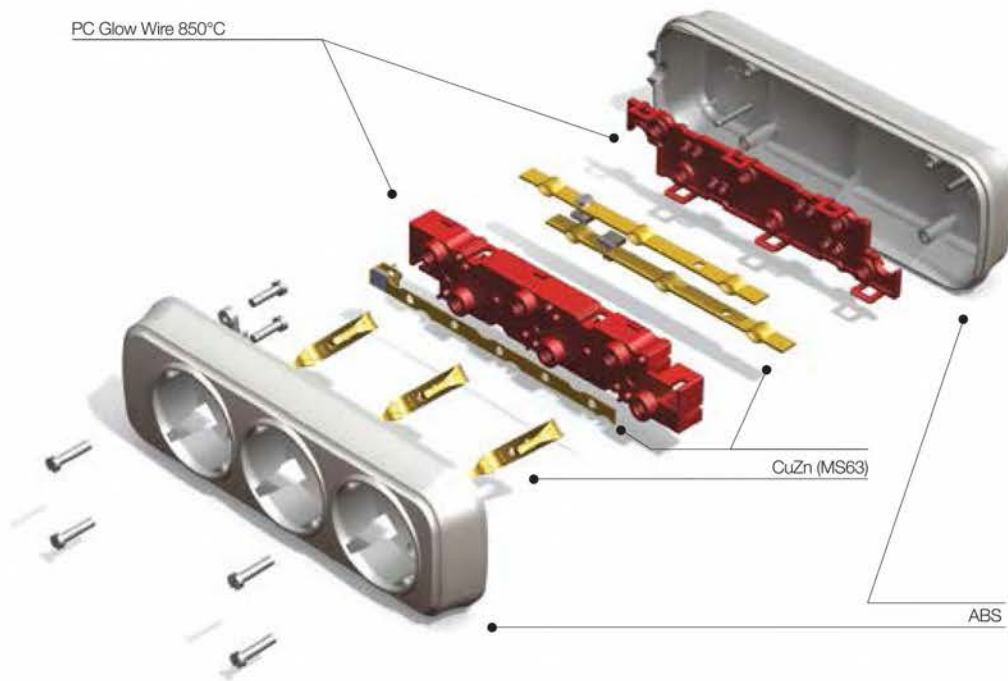

Cross Section	Overall Diameter	Conductor mm	Conductor PCS
2 x 0.75 mm <sup>2</sup>	6.4 mm	0.19	24
3 x 1 mm <sup>2</sup>	7.2 mm	0.19	32
3 x 1.5 mm <sup>2</sup>	8.5 mm	0.24	30



**TOPRAKLI 2'Lİ GRUP PRİZ / GROUNDED 2 GANG SOCKET**  
**/ КОЛОДКИ НА 2 ГНЕЗДА С/З**



**200-200-201**

Quantity in Box	1	250V~50-60Hz 16A
Quantity in Carton	36	
Carton (N/G) Weight Kg.	3,12 / 3,50	
Carton m <sup>3</sup>	0,013	



**200-202-201**

**2 M.**

Quantity in Box	1	250V~50-60Hz 16A
Quantity in Carton	12	
Carton (N/G) Weight Kg.	3,55 / 3,85	
Carton m <sup>3</sup>	0,015	



**200-203-201**

**3 M.**

Quantity in Box	1	250V~50-60Hz 16A
Quantity in Carton	12	
Carton (N/G) Weight Kg.	4,60 / 4,97	
Carton m <sup>3</sup>	0,015	



**200-205-201**

**5 M.**

Quantity in Box	1	250V~50-60Hz 16A
Quantity in Carton	12	
Carton (N/G) Weight Kg.	6,61 / 6,98	
Carton m <sup>3</sup>	0,018	



**200-207-201**

**7 M.**

Quantity in Box	1	250V~50-60Hz 16A
Quantity in Carton	12	
Carton (N/G) Weight Kg.	9,33 / 9,70	
Carton m <sup>3</sup>	0,023	



**200-210-201**

**10 M.**

Quantity in Box	1	250V~50-60Hz 16A
Quantity in Carton	12	
Carton (N/G) Weight Kg.	12,53 / 12,90	
Carton m <sup>3</sup>	0,028	



**TOPRAKLI 3'LÜ GRUP PRİZ / GROUNDED 3 GANG SOCKET**  
**КОЛОДКИ НА 3 ГНЕЗДА C/З**



**200-300-301**

Quantity in Box	1	250V~50-60Hz 16A
Quantity in Carton	36	
Carton (N/G) Weight Kg.	4,01 / 4,5	
Carton m <sup>3</sup>	0,019	



**200-302-301**

**2 M.**

Quantity in Box	1	250V~50-60Hz 16A
Quantity in Carton	12	
Carton (N/G) Weight Kg.	3,83 / 4,19	
Carton m <sup>3</sup>	0,015	



**200-303-301**

**3 M.**

Quantity in Box	1	250V~50-60Hz 16A
Quantity in Carton	12	
Carton (N/G) Weight Kg.	4,79 / 5,15	
Carton m <sup>3</sup>	0,015	



**200-305-301**

**5 M.**

Quantity in Box	1	250V~50-60Hz 16A
Quantity in Carton	12	
Carton (N/G) Weight Kg.	7,01 / 7,38	
Carton m <sup>3</sup>	0,018	



**200-307-301**

**7 M.**

Quantity in Box	1	250V~50-60Hz 16A
Quantity in Carton	12	
Carton (N/G) Weight Kg.	9,46 / 9,82	
Carton m <sup>3</sup>	0,023	



**200-310-301**

**10 M.**

Quantity in Box	1	250V~50-60Hz 16A
Quantity in Carton	12	
Carton (N/G) Weight Kg.	10,03 / 10,39	
Carton m <sup>3</sup>	0,028	





**TOPRAKLI 3'LÜ ANAHTARLI GRUP PRİZ /  
GROUNDED 3-GANG SOCKET WITH TERMINALS AND SWITCH /  
КОЛОДКИ НА 3 ГНЕЗДА С/З С ВЫКЛЮЧАТЕЛЕМ**



**200-300-302**

Quantity in Box	1	250V~50-60Hz 16A
Quantity in Carton	36	
Carton (N/G) Weight Kg.	4,95 / 5,47	
Carton m <sup>3</sup>	0,025	



**200-302-302**

**2 M.**

Quantity in Box	1	250V~50-60Hz 16A
Quantity in Carton	12	
Carton (N/G) Weight Kg.	4,23 / 4,67	
Carton m <sup>3</sup>	0,018	



**200-303-302**

**3 M.**

Quantity in Box	1	250V~50-60Hz 16A
Quantity in Carton	12	
Carton (N/G) Weight Kg.	5,30 / 5,67	
Carton m <sup>3</sup>	0,018	



**200-305-302**

**5 M.**

Quantity in Box	1	250V~50-60Hz 16A
Quantity in Carton	12	
Carton (N/G) Weight Kg.	7,11 / 7,57	
Carton m <sup>3</sup>	0,018	



**200-307-302**

**7 M.**

Quantity in Box	1	250V~50-60Hz 16A
Quantity in Carton	12	
Carton (N/G) Weight Kg.	10,06 / 10,42	
Carton m <sup>3</sup>	0,028	



**200-310-302**

**10 M.**

Quantity in Box	1	250V~50-60Hz 16A
Quantity in Carton	12	
Carton (N/G) Weight Kg.	13,30 / 13,88	
Carton m <sup>3</sup>	0,028	



**TOPRAKLI 4'LÜ GRUP PRİZ /**  
**GROUNDING 4-GANG SOCKET / КОЛОДКИ НА 4 ГНЕЗДА С/З**



**200-400-401**

Quantity in Box	1	250V~50-60Hz 16A
Quantity in Carton	36	
Carton (N/G) Weight Kg.	5,13 / 5,65	
Carton m <sup>3</sup>	0,025	



**200-402-401**

**2 M.**

Quantity in Box	1	250V~50-60Hz 16A
Quantity in Carton	12	
Carton (N/G) Weight Kg.	4,36 / 4,67	
Carton m <sup>3</sup>	0,018	



**200-403-401**

**3 M.**

Quantity in Box	1	250V~50-60Hz 16A
Quantity in Carton	12	
Carton (N/G) Weight Kg.	5,29 / 5,66	
Carton m <sup>3</sup>	0,018	



**200-405-401**

**5 M.**

Quantity in Box	1	250V~50-60Hz 16A
Quantity in Carton	12	
Carton (N/G) Weight Kg.	7,32 / 7,77	
Carton m <sup>3</sup>	0,018	



**200-407-401**

**7 M.**

Quantity in Box	1	250V~50-60Hz 16A
Quantity in Carton	12	
Carton (N/G) Weight Kg.	10,10 / 10,46	
Carton m <sup>3</sup>	0,028	



**200-410-401**

**10 M.**

Quantity in Box	1	250V~50-60Hz 16A
Quantity in Carton	12	
Carton (N/G) Weight Kg.	13,34 / 14,04	
Carton m <sup>3</sup>	0,028	



**TOPRAKLI 4'LÜ ANAHTARLI GRUP PRİZ /  
GROUNDED 4-GANG SOCKET WITH TERMINALS AND SWITCH /  
КОЛОДКИ НА 4 ГНЕЗДА С/З С ВЫКЛЮЧАТЕЛЕМ**



**200-400-402**

Quantity in Box	1	250V~50-60Hz 16A
Quantity in Carton	36	
Carton (N/G) Weight Kg.	6,26 / 6,81	
Carton m <sup>3</sup>	0,030	



**200-402-402**

**2 M.**

Quantity in Box	1	250V~50-60Hz 16A
Quantity in Carton	12	
Carton (N/G) Weight Kg.	4,56 / 5,03	
Carton m <sup>3</sup>	0,023	



**200-403-402**

**3 M.**

Quantity in Box	1	250V~50-60Hz 16A
Quantity in Carton	12	
Carton (N/G) Weight Kg.	5,67 / 6,12	
Carton m <sup>3</sup>	0,023	



**200-405-402**

**5 M.**

Quantity in Box	1	250V~50-60Hz 16A
Quantity in Carton	12	
Carton (N/G) Weight Kg.	7,68 / 8,13	
Carton m <sup>3</sup>	0,023	



**200-407-402**

**7 M.**

Quantity in Box	1	250V~50-60Hz 16A
Quantity in Carton	12	
Carton (N/G) Weight Kg.	10,29 / 10,74	
Carton m <sup>3</sup>	0,028	



**200-410-402**

**10 M.**

Quantity in Box	1	250V~50-60Hz 16A
Quantity in Carton	12	
Carton (N/G) Weight Kg.	13,91 / 14,62	
Carton m <sup>3</sup>	0,028	



**TOPRAKLI 6'LI GRUP PRİZ /**  
**GROUNDING 4-GANG SOCKET / КОЛОДКИ НА 6 ГНЁЗД С/З**



**200-600-601**

Quantity in Box	1	250V~50-60Hz 16A
Quantity in Carton	36	
Carton (N/G) Weight Kg.	7,62 / 8,33	
Carton m <sup>3</sup>	0,037	



**200-602-601**

**2 M.**

Quantity in Box	1	250V~50-60Hz 16A
Quantity in Carton	12	
Carton (N/G) Weight Kg.	5,26 / 5,85	
Carton m <sup>3</sup>	0,028	



**200-603-601**

**3 M.**

Quantity in Box	1	250V~50-60Hz 16A
Quantity in Carton	12	
Carton (N/G) Weight Kg.	6,17 / 6,85	
Carton m <sup>3</sup>	0,028	



**200-605-601**

**5 M.**

Quantity in Box	1	250V~50-60Hz 16A
Quantity in Carton	12	
Carton (N/G) Weight Kg.	8,31 / 8,89	
Carton m <sup>3</sup>	0,028	



**200-607-601**

**7 M.**

Quantity in Box	1	250V~50-60Hz 16A
Quantity in Carton	12	
Carton (N/G) Weight Kg.	10,91 / 11,49	
Carton m <sup>3</sup>	0,028	



**200-610-601**

**10 M.**

Quantity in Box	1	250V~50-60Hz 16A
Quantity in Carton	12	
Carton (N/G) Weight Kg.	14,25 / 14,83	
Carton m <sup>3</sup>	0,037	



**ТОПРАКЛИ 6'ЛИ АНАХТАРЛИ GRUP PRİZ /  
GROUNDED 6-GANG SOCKET WITH TERMINALS AND SWITCH /  
КОЛОДКИ НА 6 ГНЉЗД С/З С ВЫКЛЮЧАТЕЛЕМ**



**200-600-602**

Quantity in Box	1	250V~50-60Hz 16A
Quantity in Carton	36	
Carton (N/G) Weight Kg.	8,9 / 9,61	
Carton m <sup>3</sup>	0,037	



**200-602-602**

**2 M.**

Quantity in Box	1	250V~50-60Hz 16A
Quantity in Carton	12	
Carton (N/G) Weight Kg.	5,49 / 6,07	
Carton m <sup>3</sup>	0,028	



**200-603-602**

**3 M.**

Quantity in Box	1	250V~50-60Hz 16A
Quantity in Carton	12	
Carton (N/G) Weight Kg.	6,56 / 7,14	
Carton m <sup>3</sup>	0,028	



**200-605-602**

**5 M.**

Quantity in Box	1	250V~50-60Hz 16A
Quantity in Carton	12	
Carton (N/G) Weight Kg.	8,56 / 9,14	
Carton m <sup>3</sup>	0,028	



**200-607-602**

**7 M.**

Quantity in Box	1	250V~50-60Hz 16A
Quantity in Carton	12	
Carton (N/G) Weight Kg.	11,19 / 11,77	
Carton m <sup>3</sup>	0,028	



**200-610-602**

**10 M.**

Quantity in Box	1	250V~50-60Hz 16A
Quantity in Carton	12	
Carton (N/G) Weight Kg.	14,49 / 15,07	
Carton m <sup>3</sup>	0,037	



**TOPRAKSIZ 2'Lİ GRUP PRİZ /**  
**UNGROUNDED 2-GANG SOCKET / КОЛОДКИ НА 2 ГНЕЗДА Б/З**



**200-200-203**

Quantity in Box	1	250V~50-60Hz 10A
Quantity in Carton	36	
Carton (N/G) Weight Kg.	2,29 / 2,67	
Carton m <sup>3</sup>	0,013	



**200-202-203**

**2 M.**

Quantity in Box	1	250V~50-60Hz 10A
Quantity in Carton	12	
Carton (N/G) Weight Kg.	2,49 / 2,87	
Carton m <sup>3</sup>	0,015	



**200-203-203**

**3 M.**

Quantity in Box	1	250V~50-60Hz 10A
Quantity in Carton	12	
Carton (N/G) Weight Kg.	3,23 / 3,61	
Carton m <sup>3</sup>	0,015	



**200-205-203**

**5 M.**

Quantity in Box	1	250V~50-60Hz 10A
Quantity in Carton	12	
Carton (N/G) Weight Kg.	4,81 / 5,19	
Carton m <sup>3</sup>	0,015	



**200-207-203**

**7 M.**

Quantity in Box	1	250V~50-60Hz 10A
Quantity in Carton	12	
Carton (N/G) Weight Kg.	7,01 / 7,74	
Carton m <sup>3</sup>	0,023	



**200-210-203**

**10 M.**

Quantity in Box	1	250V~50-60Hz 10A
Quantity in Carton	12	
Carton (N/G) Weight Kg.	8,31 / 9,04	
Carton m <sup>3</sup>	0,023	



**TOPRAKSIZ 3'LÜ GRUP PRİZ /**  
**UNGROUNDED 3-GANG SOCKET / КОЛОДКИ НА 3 ГНЕЗДА Б/З**



**200-300-303**

Quantity in Box	1	250V~50-60Hz 10A
Quantity in Carton	36	
Carton (N/G) Weight Kg.	3,2 / 3,6	
Carton m <sup>3</sup>	0,018	



**200-302-303**

**2 M.**

Quantity in Box	1	250V~50-60Hz 10A
Quantity in Carton	12	
Carton (N/G) Weight Kg.	2,89 / 3,25	
Carton m <sup>3</sup>	0,015	



**200-303-303**

**3 M.**

Quantity in Box	1	250V~50-60Hz 10A
Quantity in Carton	12	
Carton (N/G) Weight Kg.	3,03 / 3,4	
Carton m <sup>3</sup>	0,015	



**200-305-303**

**5 M.**

Quantity in Box	1	250V~50-60Hz 10A
Quantity in Carton	12	
Carton (N/G) Weight Kg.	5,24 / 5,6	
Carton m <sup>3</sup>	0,015	



**200-307-303**

**7 M.**

Quantity in Box	1	250V~50-60Hz 10A
Quantity in Carton	12	
Carton (N/G) Weight Kg.	7,27 / 7,63	
Carton m <sup>3</sup>	0,023	



**200-310-303**

**10 M.**

Quantity in Box	1	250V~50-60Hz 10A
Quantity in Carton	12	
Carton (N/G) Weight Kg.	8,95 / 9,31	
Carton m <sup>3</sup>	0,023	



**TOPRAKSIZ 4'LÜ GRUP PRİZ /**  
**UNGROUNDED 4-GANG SOCKET / КОЛОДКИ НА 4 ГНЕЗДА Б/З**



**200-400-403**

Quantity in Box	1	250V~50-60Hz 10A
Quantity in Carton	36	
Carton (N/G) Weight Kg.	4,02 / 4,5	
Carton m <sup>3</sup>	0,020	



**200-402-403**

**2 M.**

Quantity in Box	1	250V~50-60Hz 10A
Quantity in Carton	12	
Carton (N/G) Weight Kg.	3,23 / 3,59	
Carton m <sup>3</sup>	0,015	



**200-403-403**

**3 M.**

Quantity in Box	1	250V~50-60Hz 10A
Quantity in Carton	12	
Carton (N/G) Weight Kg.	3,92 / 4,3	
Carton m <sup>3</sup>	0,015	



**200-405-403**

**5 M.**

Quantity in Box	1	250V~50-60Hz 10A
Quantity in Carton	12	
Carton (N/G) Weight Kg.	5,51 / 5,87	
Carton m <sup>3</sup>	0,015	



**200-407-403**

**7 M.**

Quantity in Box	1	250V~50-60Hz 10A
Quantity in Carton	12	
Carton (N/G) Weight Kg.	7,51 / 7,96	
Carton m <sup>3</sup>	0,023	



**200-410-403**

**10 M.**

Quantity in Box	1	250V~50-60Hz 10A
Quantity in Carton	12	
Carton (N/G) Weight Kg.	10,01 / 10,72	
Carton m <sup>3</sup>	0,023	



## Plugs

Fişler  
Uzatma Takımı

Extension Kit

Golyad

Golyad

Arapuar

Adaptör Fiş

Hand Switch

Adaptor Plug

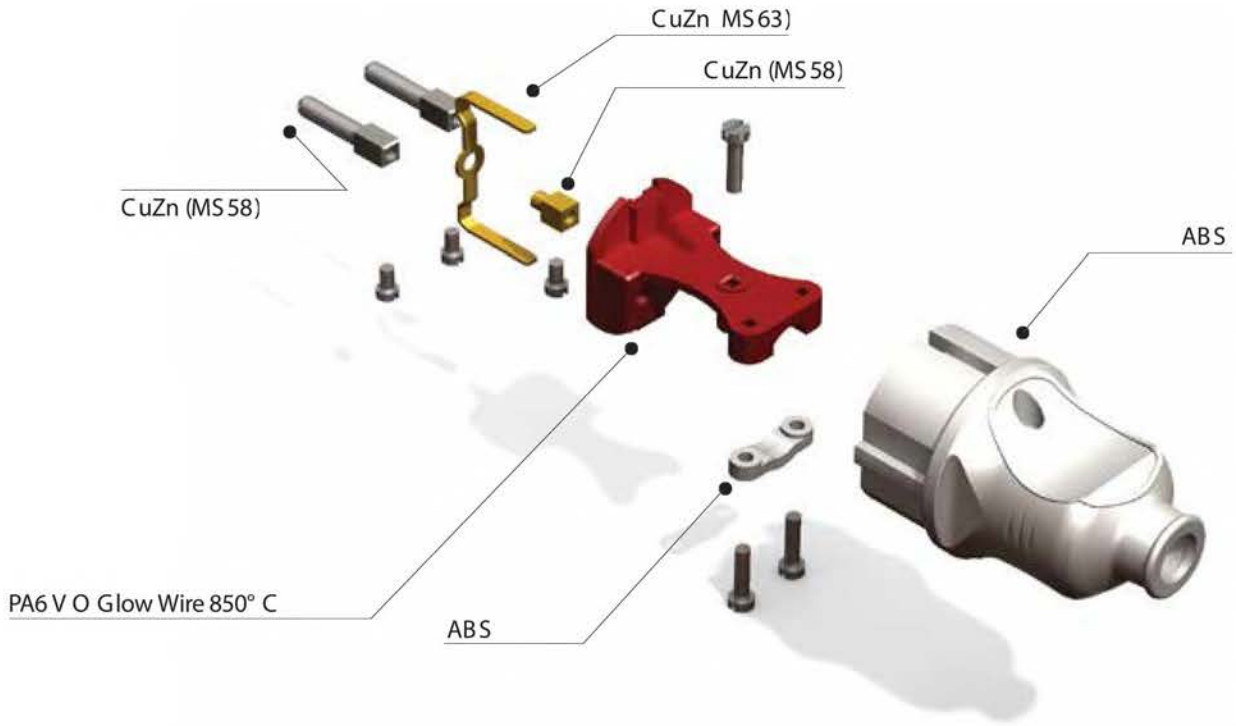



**TOPRAKLI ERKEK FİŞ**

GROUNDLED MALE PLUG

ВИЛКА С/З



**300-000-702**

Quantity in Box	50	250V~50-60Hz 16A
Quantity in Carton	400	
Carton (N/G) Weight Kg.	13,56 / 14,3	
Carton m <sup>3</sup>	0,052	

**TOPRAKLI DiŞİ FİŞ**

GROUNDLED FEMALE PLUG

ШТЕПСЕЛЬНОЕ ГНЕЗДО С/З



**300-000-706**

Quantity in Box	36	250V~50-60Hz 16A
Quantity in Carton	288	
Carton (N/G) Weight Kg.	12,42 / 13,3	
Carton m <sup>3</sup>	0,052	

**KULPLU TOPRAKLI ERKEK FİŞ**

GROUNDLED MALE PLUG WITH HANDLE

ВИЛКА УГЛОВАЯ С УШКОМ С/З



**300-000-703**

Quantity in Box	45	250V~50-60Hz 16A
Quantity in Carton	360	
Carton (N/G) Weight Kg.	12,8 / 13,5	
Carton m <sup>3</sup>	0,052	

**TOPRAKLI L TİPİ FİŞ**

GROUNDLED L TYPE PLUG

ВИЛКА УГЛОВАЯ С/З



**300-000-704**

Quantity in Box	50	250V~50-60Hz 16A
Quantity in Carton	400	
Carton (N/G) Weight Kg.	13,0 / 13,75	
Carton m <sup>3</sup>	0,052	



**TOPRAKSIZ ERKEK FİŞ**

UNGROUNDED MALE PLUG

ВИЛКА Б/З



**300-000-701**

Quantity in Box	100	250V~50-60Hz 10A
Quantity in Carton	800	
Carton (N/G) Weight Kg.	18,6 / 19,3	
Carton m <sup>3</sup>	0,052	

**TOPRAKSIZ DIŞI FİŞ**

UNGROUNDED FEMALE PLUG

ШТЕПСЕЛЬНОЕ ГНЕЗДО Б/З



**300-000-705**

Quantity in Box	50	250V~50-60Hz 10A
Quantity in Carton	400	
Carton (N/G) Weight Kg.	13,83 / 15,30	
Carton m <sup>3</sup>	0,052	

**ADAPTÖR FİŞ**

ADAPTOR PLUG

ВИЛКА ПЕРЕХОДНИК



**300-000-803**

Quantity in Box	90	250V~50-60Hz 10A
Quantity in Carton	720	
Carton (N/G) Weight Kg.	12,89 / 13,65	
Carton m <sup>3</sup>	0,052	

**İŞIKLI ANAHTAR**

ROCKERSWITCH

ВЫКЛЮЧАТЕЛЬ



**300-000-709**

Quantity in Box	150	250V~50-60Hz 16A
Quantity in Carton	1200	
Carton (N/G) Weight Kg.	20,5 / 22	
Carton m <sup>3</sup>	0,052	



**KAUÇUK TOPRAKLI ERKEK FİŞ**

GROUNDING RUBBER MALE PLUG

КАУЧУКОВАЯ ВИЛКА С/З



**300-000-804**

Quantity in Box	40	250V~50-60Hz 16A
Quantity in Carton	320	
Carton (N/G) Weight Kg.	12,17 / 13,65	
Carton m <sup>3</sup>	0,052	

**KAUÇUK TOPRAKLI DIŞI FİŞ**

GROUNDING RUBBER FEMALE PLUG

КАУЧУКОВОЕ ШТЕПСЕЛЬНОЕ ГНЕЗДО С/З



**300-000-805**

Quantity in Box	25	250V~50-60Hz 16A
Quantity in Carton	200	
Carton (N/G) Weight Kg.	9,62 / 11,11	
Carton m <sup>3</sup>	0,052	

**ARAPUAR**

HAND SWITCH

ВЫКЛЮЧАТЕЛЬ ДЛЯ БРА



SIYAH-KIRMIZI / RED-BLACK  
КРАСНЫЙ-ЧЕРНЫЙ

**300-003-708**



BEYAZ-KIRMIZI / RED-WHITE  
КРАСНЫЙ-БЕЛЫЙ

**300-002-708**



BEYAZ-BEYAZ / WHITE  
БЕЛЫЙ

**300-001-708**

Quantity in Box	120	250V~50-60Hz 10A
Quantity in Carton	960	
Carton (N/G) Weight Kg.	18,03 / 19,50	
Carton m <sup>3</sup>	0,052	

**TOPRAKLI 3'LÜ FİŞ PRİZ (GOLYAD)**

GROUNDED 3 GANG PLUG SOCKED (GOLYAD)

ТРОЙНАЯ РОЗЕТКА С/3 (GOLYAD)

**300-000-707**

Quantity in Box	1	<b>250V~50-60Hz 16A</b>
Quantity in Carton	40	
Carton (N/G) Weight Kg.	4,02 / 4,56	
Carton m <sup>3</sup>	0,025	

**TOPRAKSIZ 3'LÜ FİŞ PRİZ (GOLYAD)**

UNGROUNDED 3 GANG PLUG SOCKED (GOLYAD)

ТРОЙНАЯ РОЗЕТКА Б/3 (GOLYAD)

**300-000-802**

Quantity in Box	1	<b>250V~50-60Hz 10A</b>
Quantity in Carton	40	
Carton (N/G) Weight Kg.	2,31 / 2,81	
Carton m <sup>3</sup>	0,025	

**TOPRAKLI UZATMA TAKIMI**

GROUNDED EXTENSION KIT

УДЛИНИТЕЛЬ КАБЕЛЯ С/З

**300-003-801****3 M.**

Quantity in Box	1	250V~50-60Hz 16A
Quantity in Carton	12	
Carton (N/G) Weight Kg.	4,33 / 4,80	
Carton m <sup>3</sup>	0,015	

**300-005-801****5 M.**

Quantity in Box	1	250V~50-60Hz 16A
Quantity in Carton	12	
Carton (N/G) Weight Kg.	6,37 / 6,84	
Carton m <sup>3</sup>	0,018	

**TOPRAKSIZ UZATMA TAKIMI**

UNGROUNDING EXTENSION KIT

УДЛИНИТЕЛЬ КАБЕЛЯ Б/З

**300-003-800****3 M.**

Quantity in Box	1	250V~50-60Hz 10A
Quantity in Carton	12	
Carton (N/G) Weight Kg.	3,16 / 3,63	
Carton m <sup>3</sup>	0,015	

**300-005-800****5 M.**

Quantity in Box	1	250V~50-60Hz 10A
Quantity in Carton	12	
Carton (N/G) Weight Kg.	4,72 / 5,19	
Carton m <sup>3</sup>	0,015	



PLASTİK FAN

PLASTIC FANS

ПЛАСТИКОВЫЕ ВЕНТИЛЯТОРЫ



Operation Voltage	220-240V / 50-60Hz
Airflow	100m³/h
Speed	2250 rpm
Power	12W

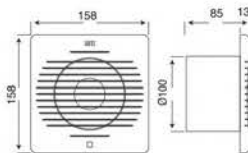

500-000-100

Quantity in Box	1
Quantity in Carton	20
Carton (N/G) Weight Kg.	8,8 / 10,3
Carton m³	0,047



Operation Voltage	220-240V / 50-60Hz
Airflow	120m³/h
Speed	1900 rpm
Power	15W

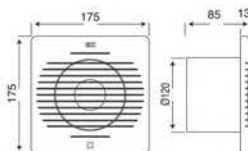

500-000-120

Quantity in Box	1
Quantity in Carton	20
Carton (N/G) Weight Kg.	9,7 / 11,22
Carton m³	0,059



Operation Voltage	220-240V / 50-60Hz
Airflow	150m³/h
Speed	1800 rpm
Power	20W

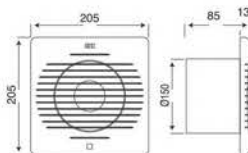

500-000-150

Quantity in Box	1
Quantity in Carton	20
Carton (N/G) Weight Kg.	13,9 / 15,91
Carton m³	0,098



Operation Voltage	220-240V / 50-60Hz
Airflow	200m³/h
Speed	2000 rpm
Power	40W

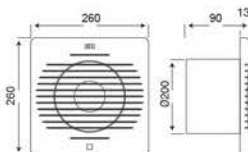

500-000-200

Quantity in Box	1
Quantity in Carton	10
Carton (N/G) Weight Kg.	13,3 / 14,8
Carton m³	0,093



## 360° SENSÖRLÜ TAVAN ARMATÜRÜ

LIGHTING FIXTURE WITH 360° MOTION SENSOR

ПОТОЛОЧНЫЙ СВЕТИЛЬНИК С 360° ДАТЧИКОМ ДВИЖЕНИЯ



400-001-112



400-002-112



400-000-112

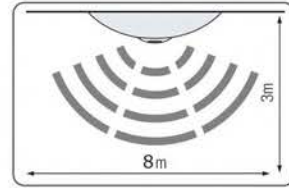

Quantity in Box	1
Quantity in Carton	10
Carton (N/G) Weight Kg.	8,40 / 11,19
Carton m <sup>3</sup>	0,11

230V~50-60Hz  
max 2x25W

**KULLANIM ALANLARI**  
Merdiven Aydınlatmaları  
Bina Girişleri  
Koridorlar  
Kapalı Otoparklar  
Otel, Hastane, Okul,  
Akaryakıt İstasyonları...



E27 Max 2x25W

**360° SENSÖRLÜ TAVAN ARMATÜRÜ**  
ALGILAMA MESAFESİ : 8m (max)  
ZAMAN AYAR ARALIĞI : 15-270sn  
ORTAM IŞIK AYAR ARALIĞI: 2-240Lux  
ÇALIŞMA SICAKLIĞI : -20°/+75°  
KORUMA SINIFI : IP20





NEMLİ YER / WATERPROOF / ВОДОНЕПРОНИЦАЕМЫЙ

AQUA YARIMAY MİKROSENSÖRLÜ E27 / AQUA HALFMOON WITH MICRO SENSOR E27 /  
АКУА ПОЛУМЕСЯЦ С МИКРО СЕНСОРОМ E27



SIYAH - OPAL / BLACK - OPAL  
/ ЧЁРНЫЙ - ОПАЛ

E27+Sensör

400 223 114



360°  
MICROSENSOR



BEYAZ - OPAL / WHITE - OPAL  
/ БЕЛЫЙ - ОПАЛ

E27+Sensör

400 213 114

Quantity in Box	1	230V~50-60HZ max 40W
Quantity in Carton	20	
Carton (N/G) Weight Kg.	7,9 / 10	
Carton m <sup>3</sup>	0.112	

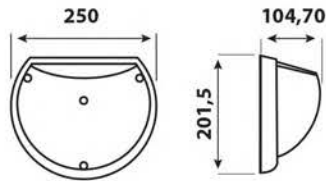



NEMLİ YER / WATERPROOF / ВОДОНЕПРОНИЦАЕМЫЙ

AQUA DOLUNAY MİKROSENSÖRLÜ E27 / AQUA FULLMOON WITH MICRO SENSOR E27 /  
АКУА ПОЛНАЯ ЛУНА С МИКРО СЕНСОРОМ E27



SİYAH - OPAL / BLACK - OPAL  
/ ЧЁРНЫЙ - ОПАЛ

E27+Sensör

400 223 115



360°  
MICROSENSOR

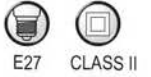

BEYAZ - OPAL / WHITE - OPAL  
/ БЕЛЫЙ-ОПАЛ

E27+Sensör

400 213 115

Quantity in Box	1
Quantity in Carton	16
Carton (N/G) Weight Kg.	7,3 / 9,4
Carton m <sup>3</sup>	0,104

230V~50-60Hz  
max 40W

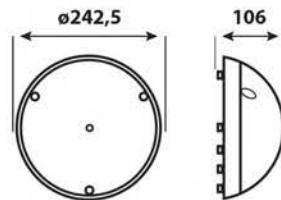



NEMLİ YER / WATERPROOF / ВОДОНЕПРОНИЦАЕМЫЙ

AQUA YARIMAY LEDLİ SENSÖRLÜ / LED AQUA HALFMOON WITH MICRO SENSOR /  
АКУА ПОЛУМЕСЯЦ СВЕТОДИОДНЫЙ С МИКРО СЕНСОРОМ



SİYAH - OPAL / BLACK - OPAL  
/ ЧЁРНЫЙ - ОПАЛ

Led+Sensör

9W 3000K

400 423 114

9W 6400K

400 425 114

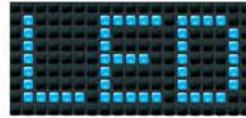

360°  
MICROSENSOR



BEYAZ - OPAL / WHITE - OPAL  
/ БЕЛЫЙ-ОПАЛ

Led+Sensör

9W 3000K

400 413 114

9W 6400K

400 415 114

Quantity in Box	1	230V~50-60Hz
Quantity in Carton	20	
Carton (N/G) Weight Kg.	7,970 / 10,21	
Carton m <sup>3</sup>	0,11	

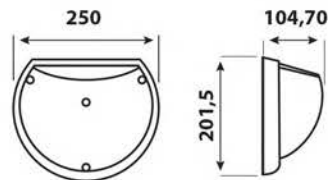



NEMLİ YER / WATERPROOF / ВОДОНЕПРОНИЦАЕМЫЙ

AQUA DOLUNAY LEDLİ SENSÖRLÜ / LED AQUA FULLMOON WITH MICRO SENSOR /  
АКУА ПОЛНАЯ ЛУНА СВЕТОДИОДНЫЙ С МИКРО СЕНСОРОМ



SİYAH - OPAL / BLACK - OPAL  
/ ЧЁРНЫЙ - ОПАЛ

Led+Sensör

12W 3000K

400 423 115

12W 6400K

400 425 115

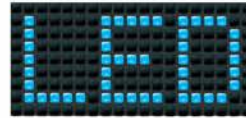

360°  
MICROSENSOR



BEYAZ - OPAL / WHITE - OPAL  
/ БЕЛЫЙ - ОПАЛ

Led+Sensör

12W 3000K

400 413 115

12W 6400K

400 415 115



Quantity in Box	1
Quantity in Carton	16
Carton (N/G) Weight Kg.	6,795 / 8,94
Carton m <sup>3</sup>	0,10

230V~50-60Hz

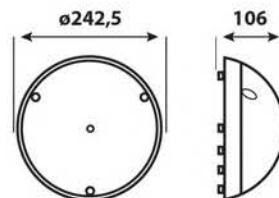



NEMLİ YER / WATERPROOF / ВОДОНЕПРОНИЦАЕМЫЙ

TOROS NEMLİYER ARMATÜRÜ / TOROS ALUMINIUM BULKHEAD LAMP /  
ТОРОС ПЫЛЕВЛАГОЗАЩИЩЕННЫЙ СВЕТИЛЬНИК



SİYAH / BLACK  
ЧЁРНЫЙ

E27

400 001 119



BEYAZ / WHITE  
БЕЛЫЙ

E27

400 000 119



Quantity in Box	1	230V~50-60Hz max 60W
Quantity in Carton	20	
Carton (N/G) Weight Kg.	10,5 / 12,1	
Carton m <sup>3</sup>	0,04	

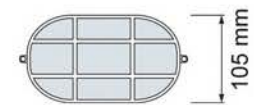
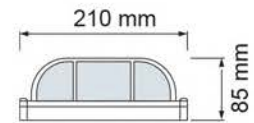



NEMLİ YER / WATERPROOF / ВОДОНЕПРОНИЦАЕМЫЙ

AQUA EKO / AQUA ECO / АКУА ЭКО



SİYAH / BLACK  
ЧЁРНЫЙ

400-000-108



BEYAZ / WHITE  
БЕЛЫЙ

400-001-108

Quantity in Box	1
Quantity in Carton	16
Carton (N/G) Weight Kg.	6,42 / 7,93
Carton m <sup>3</sup>	0,084

250V~50-60Hz  
max 26W(ESL)

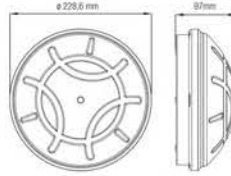

AQUA OPAK APLİK / AQUA OPAK WALL FIXTURE / АКУА ОПАК



SİYAH / BLACK  
ЧЁРНЫЙ

400-001-113



BEYAZ / WHITE  
БЕЛЫЙ

400-000-113

Quantity in Box	1
Quantity in Carton	24
Carton (N/G) Weight Kg.	6,5 / 8,5
Carton m <sup>3</sup>	0,091

230V~50-60Hz  
max 26W(ESL)

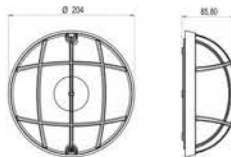



NEMLİ YER / WATERPROOF / ВОДОНЕПРОНИЦАЕМЫЙ

AQUA APLİK / AQUA WALL FIXTURE / АКУА НАСТЕННЫЙ СВЕТИЛЬНИК

BEYAZ / WHITE  
БЕЛЫЙ

400-000-111

SİYAH / BLACK  
ЧЁРНЫЙ

400-002-111



Quantity in Box	1	230V~50-60HZ max 26W(ESL)
Quantity in Carton	20	
Carton (N/G) Weight Kg.	4,74 / 6,27	
Carton m <sup>3</sup>	0,066	

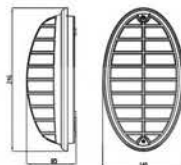



NEMLİ YER / WATERPROOF / ВОДОНЕПРОНИЦАЕМЫЙ

AQUA OPAL / AQUA OPAL / АКУА ОПАЛ

OPAL / OPAL / ОПАЛ



BEYAZ / WHITE  
БЕЛЫЙ

400-010-105



SİYAH / BLACK  
ЧЕРНЫЙ

400-011-105



GRİ / GREY  
СЕРЫЙ

400-012-105

BUZLU / FROSTED / ИНЕЙ



BEYAZ / WHITE  
БЕЛЫЙ

400-000-105



SİYAH / BLACK  
ЧЕРНЫЙ

400-001-105



GRİ / GREY  
СЕРЫЙ

400-002-105

Quantity in Box	1	230V~50-60Hz max 60W
Quantity in Carton	10	
Carton (N/G) Weight Kg.	6,06 / 7,57	
Carton m <sup>3</sup>	0,081	

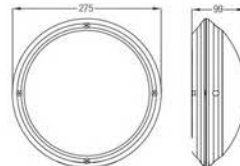





NEMLİ YER / WATERPROOF / ВОДОНЕПРОНИЦАЕМЫЙ

AQUA OVAL OPAL / AQUA OVAL OPAL / АКУА ОПАЛ ОВАЛЬНЫЙ

OPAL / OPAL / ОПАЛ



BEYAZ / WHITE  
БЕЛЫЙ

400-010-106



SİYAH / BLACK  
ЧЕРНЫЙ

400-011-106



GRİ / GREY  
СЕРЫЙ

400-012-106

BUZLU / FROSTED / ИНЕЙ



BEYAZ / WHITE  
БЕЛЫЙ

400-000-106



SİYAH / BLACK  
ЧЕРНЫЙ

400-001-106



GRİ / GREY  
СЕРЫЙ

400-002-106

Quantity in Box	1
Quantity in Carton	10
Carton (N/G) Weight Kg.	8,04 / 9,54
Carton m <sup>3</sup>	0,082

230V~50-60Hz  
max 60W

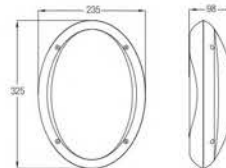



NEMLİ YER / WATERPROOF / ВОДОНЕПРОНИЦАЕМЫЙ

AQUA YARIMAY E27 / AQUA HALFMOON E27 / АКУА ПОЛУМЕСЯЦ E27



SİYAH - OPAL / BLACK - OPAL  
/ ЧЁРНЫЙ - ОПАЛ

E27

400 123 114



BEYAZ - OPAL / WHITE - OPAL  
/ БЕЛЫЙ - ОПАЛ

E27

400 113 114



SİYAH - BUZLU / BLACK - FROST  
/ ЧЁРНЫЙ - ИНЕЙ

E27

400 124 114



BEYAZ - BUZLU / WHITE - FROST  
/ БЕЛЫЙ - ИНЕЙ

E27

400 114 114



Quantity in Box	1	230V~50-60Hz max 40W
Quantity in Carton	20	
Carton (N/G) Weight Kg.	7,2 / 9,3	
Carton m <sup>3</sup>	0.112	

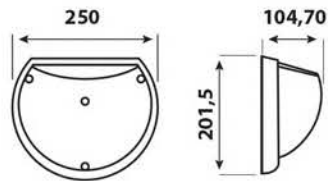



NEMLİ YER / WATERPROOF / ВОДОНЕПРОНИЦАЕМЫЙ

AQUA DOLUNAY E27 / AQUA FULLMOON E27 / АКУА ПОЛНАЯ ЛУНА E27



SİYAH - OPAL / BLACK - OPAL  
/ ЧЁРНЫЙ - ОПАЛ

E27

400 123 115



BEYAZ - OPAL / WHITE - OPAL  
/ БЕЛЫЙ - ОПАЛ

E27

400 113 115



SİYAH - BUZLU / BLACK - FROST  
/ ЧЁРНЫЙ - ИНЕЙ

E27

400 124 115



BEYAZ - BUZLU / WHITE - FROST  
/ БЕЛЫЙ - ИНЕЙ

E27

400 114 115



Quantity in Box	1	230V~50-60Hz max 40W
Quantity in Carton	16	
Carton (N/G) Weight Kg.	6 / 8,1	
Carton m <sup>3</sup>	0,104	

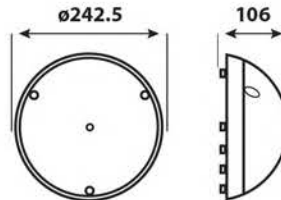



NEMLİ YER / WATERPROOF / ВОДОНЕПРОНИЦАЕМЫЙ

LEDLİ AQUA YARIMAY / AQUA HALFMOON LED / АКУА ПОЛУМЕСЯЦ СВЕТОДИОДНЫЙ



SİYAH - OPAL / BLACK - OPAL  
/ ЧЁРНЫЙ - ОПАЛ

LED

9W 3000K

400 323 114

9W 6400K

400 325 114

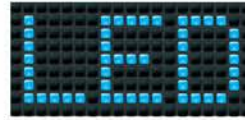

BEYAZ - OPAL / WHITE - OPAL  
/ БЕЛЫЙ - ОПАЛ

LED

9W 3000K

400 313 114

9W 6400K

400 315 114



Quantity in Box	1
Quantity in Carton	20
Carton (N/G) Weight Kg.	7,97 / 10,21
Carton m <sup>3</sup>	0,112

230V~50-60Hz

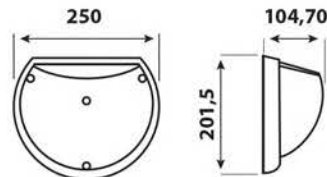



NEMLİ YER / WATERPROOF / ВОДОНЕПРОНИЦАЕМЫЙ

LEDLİ AQUA DOLUNAY / AQUA FULLMOON LED / АКУА ПОЛНАЯ ЛУНА СВЕТОДИОДНЫЙ



SIYAH - OPAL / BLACK - OPAL  
/ ЧЁРНЫЙ - ОПАЛ

LED

12W 3000K

400 323 115

12W 6400K

400 325 115



BEYAZ - OPAL / WHITE - OPAL  
/ БЕЛЫЙ - ОПАЛ

LED

12W 3000K

400 313 115

12W 6400K

400 315 115



Quantity in Box	1
Quantity in Carton	16
Carton (N/G) Weight Kg.	6,8 / 8,95
Carton m <sup>3</sup>	0,104

230V~50-60Hz

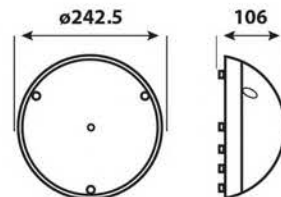



UFO / UFO / УФО

RÜZGAR GÜLÜ / WIND ROSE / РОЗА ВЕТРОВ

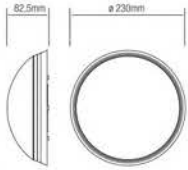

CEVİZ / WALNUT  
OPEX

400-231-101

Quantity in Box	5	230V~50-60HZ max 15W(ESL)
Quantity in Carton	40	
Carton (N/G) Weight Kg.	10,6 / 10,85	
Carton m <sup>3</sup>	0,085	



GÜMÜŞ / SILVER  
СЕРЕБРО

400-201-101



FÜME / FUME  
ДЫМЧАТЫЙ

400-211-101



BEYAZ / WHITE  
БЕЛЫЙ

400-001-101



KAYIN / MAPLE  
БУК

400-221-101

NAZAR / NAZAR / НАЗАР



GÜMÜŞ / SILVER  
СЕРЕБРО

400-202-101



FÜME / FUME  
ДЫМЧАТЫЙ

400-212-101



CEVİZ / WALNUT  
OPEX

400-232-101



KAYIN / MAPLE  
БУК

400-222-101



BEYAZ / WHITE  
БЕЛЫЙ

400-002-101

Quantity in Box	5	230V~50-60HZ max 15W(ESL)
Quantity in Carton	40	
Carton (N/G) Weight Kg.	11,42 / 11,66	
Carton m <sup>3</sup>	0,085	



UFO / UFO / УФО

ZAGREP / ZAGREP / ЗАГРЕБ

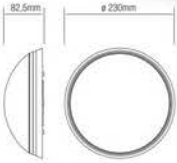

KAYIN / MAPLE  
БУК

400-223-101



GÜMÜŞ / SILVER  
СЕРЕБРО

400-203-101



FÜME / FUME  
ДЫМЧАТЫЙ

400-213-101



CEVİZ / WALNUT  
ОРЕХ

400-233-101



BEYAZ / WHITE  
БЕЛЫЙ

400-003-101

Quantity in Box	5	230V~50-60Hz max 15W(ESL)
Quantity in Carton	40	
Carton (N/G) Weight Kg.	11,02 / 11,3	
Carton m <sup>3</sup>	0,085	

ERCIYES / ERCIYES / ЭРДЖИЕС



BEYAZ / WHITE  
БЕЛЫЙ

400-004-101



FÜME / FUME  
ДЫМЧАТЫЙ

400-214-101



GÜMÜŞ / SILVER  
СЕРЕБРО

400-204-101



CEVİZ / WALNUT  
ОРЕХ

400-234-101



KAYIN / MAPLE  
БУК

400-224-101

Quantity in Box	5	230V~50-60Hz max 15W(ESL)
Quantity in Carton	40	
Carton (N/G) Weight Kg.	10,74 / 11,0	
Carton m <sup>3</sup>	0,085	

UFO / UFO / УФО

YILDIZ / YILDIZ / ЗВЕЗДА

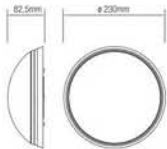

FÜME / FUME  
ДЫМЧАТЫЙ

400-124-101



GÜMÜŞ / SILVER  
СЕРЕБРО

400-123-101



BEYAZ / WHITE  
БЕЛЫЙ

400-022-101



CEVİZ / WALNUT  
ОРЕХ

400-126-101



KAYIN / MAPLE  
БУК

400-125-101

Quantity in Box	5
Quantity in Carton	40
Carton (N/G) Weight Kg.	10,52 / 10,76
Carton m <sup>3</sup>	0,085

230V~50-60Hz  
max 15W(ESL)

LOLY / LOLLY / ЛОЛЛИ

**NEW** OPEN-CLOSE SYSTEM  
WITHOUT SCREW

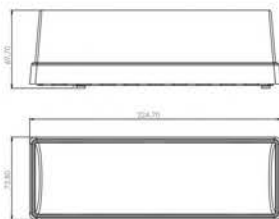

BEYAZ / WHITE  
БЕЛЫЙ

400-000-110

Quantity in Box	5
Quantity in Carton	60
Carton (N/G) Weight Kg.	9,63 / 10,78
Carton m <sup>3</sup>	0,054

230V~50-60Hz  
max 15W(ESL)





GLOP / GLOP / ГЛОП

RÜZGAR GÜLÜ / WIND ROSE / РОЗА ВЕТРОВ

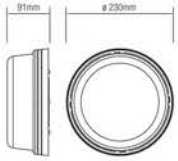

FÜME / FUME  
ДЫМЧАТЫЙ

400-211-100

Quantity in Box	4	230V~50-60Hz max 26W (ESL)
Quantity in Carton	32	
Carton (N/G) Weight Kg.	11,28 / 11,44	
Carton m <sup>3</sup>	0,085	



GÜMÜŞ / SILVER  
СЕРЕБРО

400-201-100



BEYAZ / WHITE  
БЕЛЫЙ

400-001-100



CEVİZ / WALNUT  
ОРЕХ

400-231-100



KAYIN / MAPLE  
БУК

400-221-100

FAVORI / FAVORI / ФАВОРИ



GÜMÜŞ / SILVER  
СЕРЕБРО

400-202-100



FÜME / FUME  
ДЫМЧАТЫЙ

400-212-100



CEVİZ / WALNUT  
ОРЕХ

400-232-100



KAYIN / MAPLE  
БУК

400-222-100



BEYAZ / WHITE  
БЕЛЫЙ

400-002-100

Quantity in Box	4	230V~50-60Hz max 26W (ESL)
Quantity in Carton	32	
Carton (N/G) Weight Kg.	11,11 / 11,35	
Carton m <sup>3</sup>	0,085	



APLIK / WALL FIXTURE / НАСТЕННЫЙ СВЕТИЛЬНИК

FLUE / FLUE / ФЛУЕ



BEYAZ / WHITE  
БЕЛЫЙ

400-000-107



GÜMÜŞ / SILVER  
СЕРЕБРО

400-001-107



FÜME / FUME  
ДЫМЧАТЫЙ

400-002-107



CEVİZ / WALNUT  
ОРЕХ

400-003-107



KAYIN / MAPLE  
БУК

400-004-107

Quantity in Box	4	230V~50-60Hz max 26W (ESL)
Quantity in Carton	36	
Carton (N/G) Weight Kg.	8,01 / 9,28	
Carton m <sup>3</sup>	0,064	

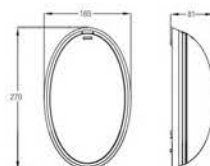

NİNOVA / NİNOVA / НИНОВА



GÜMÜŞ / SILVER  
СЕРЕБРО

400-011-107



FÜME / FUME  
ДЫМЧАТЫЙ

400-012-107



CEVİZ / WALNUT  
ОРЕХ

400-013-107



KAYIN / MAPLE  
БУК

400-014-107



BEYAZ / WHITE  
БЕЛЫЙ

400-010-107



UFO ÇİFT DUYLU / UFO WITH TWO LAMP HOLDERS / УФО С ДВУМЯ ПАТРОНАМИ

**BULUT / BULUT / ОБЛАКО**



CEVİZ / WALNUT  
OPEX

400-030-104

Quantity in Box	1	230V~50-60Hz max 2x28W (ESL)
Quantity in Carton	5	
Carton (N/G) Weight Kg.	3,50 / 4,90	
Carton m <sup>3</sup>	0,089	

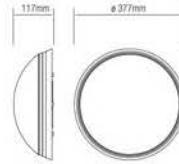

GÜMÜŞ / SILVER  
СЕРЕБРО

400-010-104



ALTIN / GOLD  
МАТОВОЕ ЗОЛОТО

400-020-104



BEYAZ / WHITE  
БЕЛЫЙ

400-000-104



KAYIN / MAPLE  
БУК

400-040-104

**ZAGREP / ZAGREP / ЗАГРЕБ**



GÜMÜŞ / SILVER  
СЕРЕБРО

400-011-104



ALTIN / GOLD  
МАТОВОЕ ЗОЛОТО

400-021-104



CEVİZ / WALNUT  
OPEX

400-031-104



KAYIN / MAPLE  
БУК

400-041-104



BEYAZ / WHITE  
БЕЛЫЙ

400-001-104



KARE ARMATÜR / SQUARE LIGHTING FIXTURE / КВАДРАТНАЯ АРМАТУРА

**KARE KLASİK / SQUARE CLASSIC /  
КВАДРАТНАЯ КЛАССИКА**

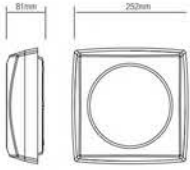

BEYAZ / WHITE  
БЕЛЫЙ

400-000-102



GÜMÜŞ / SILVER  
СЕРЕБРО

400-010-102



ALTIN / GOLD  
МАТОВОЕ ЗОЛОТО

400-020-102



CEVİZ / WALNUT  
ОРЕХ

400-030-102



KAYIN / MAPLE  
БУК

400-040-102

TEKLİ / 1 piece

DÖRTLÜ / 4 pieces

230V~50-60Hz  
max 2x26W (ESL)

Quantity in Box	1
Quantity in Carton	12
Carton (N/G) Weight Kg.	4,78 / 6,21
Carton m <sup>3</sup>	0,066

Quantity in Box	4
Quantity in Carton	24
Carton (N/G) Weight Kg.	8,98 / 9,78
Carton m <sup>3</sup>	0,60

**KARE MODERN / SQUARE MODERN / КВАДРАТНЫЙ МОДЕРН**



GÜMÜŞ / SILVER  
СЕРЕБРО

400-011-102



ALTIN / GOLD  
МАТОВОЕ ЗОЛОТО

400-021-102



CEVİZ / WALNUT  
ОРЕХ

400-031-102



KAYIN / MAPLE  
БУК

400-041-102



BEYAZ / WHITE  
БЕЛЫЙ

400-001-102

TEKLİ / 1 piece

DÖRTLÜ / 4 pieces

Quantity in Box	1
Quantity in Carton	12
Carton (N/G) Weight Kg.	4,67 / 6,10
Carton m <sup>3</sup>	0,066

Quantity in Box	4
Quantity in Carton	24
Carton (N/G) Weight Kg.	8,62 / 9,42
Carton m <sup>3</sup>	0,60

230V~50-60Hz  
max 2x26W (ESL)



ÇİFT DUYLU KARE ARMATÜR / SQUARE FIXTURE WITH TWO LAMPHOLDER /  
КВАДРАТНАЯ АРМАТУРА С ДВУМЯ ПАТРОНАМИ

**KARE KLASİK / SQUARE CLASSIC /  
КВАДРАТНАЯ КЛАССИКА**



GÜMÜŞ / SILVER  
СЕРЕБРО

400-010-103



ALTIN / GOLD  
МАТОВОЕ ЗОЛОТО

400-020-103



CEVİZ / WALNUT  
ОРЕХ

400-030-103



KAYIN / MAPLE  
БУК

400-040-103

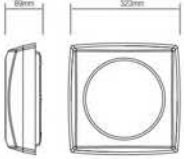

BEYAZ / WHITE  
БЕЛЫЙ

400-000-103

Quantity in Box	1
Quantity in Carton	10
Carton (N/G) Weight Kg.	8,51 / 9,71
Carton m <sup>3</sup>	0,10

230V~50-60Hz  
max 2x26W (ESL)

**KARE MODERN / SQUARE MODERN / КВАДРАТНЫЙ МОДЕРН**



GÜMÜŞ / SILVER  
СЕРЕБРО

400-011-103



ALTIN / GOLD  
МАТОВОЕ ЗОЛОТО

400-021-103



CEVİZ / WALNUT  
ОРЕХ

400-031-103



KAYIN / MAPLE  
БУК

400-041-103



BEYAZ / WHITE  
БЕЛЫЙ

400-001-103



Quantity in Box	1
Quantity in Carton	10
Carton (N/G) Weight Kg.	8,44 / 9,64
Carton m <sup>3</sup>	0,10

230V~50-60Hz  
max 2x26W (ESL)



BAHÇE AYDINLATMASI / GARDEN LAMP / САДОВО-ПАРКОВЫЕ СВЕТИЛЬНИКИ



BEYAZ - WHITE - БЕЛЫЙ

BEGONYA-2

E27

400 020 117

Quantity in Box	1	230V~50-60Hz max 40W
Quantity in Carton	12	
Carton (N/G) Weight Kg.	4,75 / 6,42	
Carton m <sup>3</sup>	0,13	



SİYAH - BLACK - ЧЁРНЫЙ

BEGONYA-2

E27

400 010 117



BAHÇE AYDINLATMASI / GARDEN LAMP / САДОВО-ПАРКОВЫЕ СВЕТИЛЬНИКИ



BEYAZ - WHITE - БЕЛЫЙ

BEGONYA - 1

E27

400 020 116

Quantity in Box	1	230V-50-60Hz max 40W
Quantity in Carton	12	
Carton (N/G) Weight Kg.	4,75/ 6,42	
Carton m <sup>3</sup>	0,13	



SİYAH - BLACK - ЧЁРНЫЙ

BEGONYA - 1

E27

400 010 116



BAHÇE AYDINLATMASI / GARDEN LAMP / САДОВО-ПАРКОВЫЕ СВЕТИЛЬНИКИ



SİYAH - BLACK - ЧЁРНЫЙ



BEYAZ - WHITE - БЕЛЫЙ



**BEGONYA - 3**

E27      400 010 118

**BEGONYA - 3**

E27      400 020 118

Quantity in Box	1	230V~50-60Hz max 40W
Quantity in Carton	12	
Carton (N/G) Weight Kg.	4,75 / 6,42	
Carton m <sup>3</sup>	0,13	







BAHÇE AYDINLATMASI / GARDEN LAMP / САДОВО-ПАРКОВЫЕ СВЕТИЛЬНИКИ

BAHÇE APLİK / GARDEN WALL LAMP / НАСТЕННЫЙ СВЕТИЛЬНИК



SİYAH - BLACK - ЧЁРНЫЙ



BEYAZ - WHITE - БЕЛЫЙ

BAHÇE APLİK

E27

400 010 120

BAHÇE APLİK

E27

400 020 120



Quantity in Box	1	230V~50-60Hz max 40W
Quantity in Carton	24	
Carton (N/G) Weight Kg.	5,8 / 8,90	
Carton m <sup>3</sup>	0,15	





SİGORTA KUTUSU / DISTRIBUTION BOX / ЭЛЕКТРОЩИТОК

12'Lİ SIVAÜSTÜ / SURFACE MOUNT / НАКЛАДНОЙ



BEYAZ - WHITE - БЕЛЫЙ

600 000 120



SİYAH - BLACK - ЧЁРНЫЙ

600 001 120

12'Lİ SIVAALTI / FLUSH MOUNT / ВСТРАИВАЕМЫЙ



BEYAZ - WHITE - БЕЛЫЙ

600 000 121



SİYAH - BLACK - ЧЁРНЫЙ

600 001 121

SIVAÜSTÜ	SURFACE MOUNT	НАКЛАДНОЙ
Quantity in Box	1	
Quantity in Carton	12	
Carton (N/G) Weight Kg.	7,93 / 9,36	
Carton m <sup>3</sup>	0,091	

SIVAALTI	FLUSH MOUNT	ВСТРАИВАЕМЫЙ
Quantity in Box	1	
Quantity in Carton	12	
Carton (N/G) Weight Kg.	6,62 / 8,04	
Carton m <sup>3</sup>	0,091	





SİGORTA KUTUSU / DISTRIBUTION BOX / ЭЛЕКТРОЩИТОК

4'LÜ SIVAÜSTÜ / SURFACE MOUNT / НАКЛАДНОЙ



BEYAZ - WHITE - БЕЛЫЙ

600 010 400



SİYAH - BLACK - ЧЁРНЫЙ

600 001 400

4'LÜ SIVAALTI / FLUSH MOUNT / ВСТРАИВАЕМЫЙ



BEYAZ - WHITE - БЕЛЫЙ

600 000 401



SİYAH - BLACK - ЧЁРНЫЙ

600 001 401

SIVAÜSTÜ	SURFACE MOUNT	НАКЛАДНОЙ
Quantity in Box		1
Quantity in Carton		12
Carton (N/G) Weight Kg.		4,75 / 6,42
Carton m <sup>3</sup>		0,13

SIVAALTI	FLUSH MOUNT	ВСТРАИВАЕМЫЙ
Quantity in Box		1
Quantity in Carton		12
Carton (N/G) Weight Kg.		4,75 / 6,42
Carton m <sup>3</sup>		0,13





SİGORTA KUTUSU / DISTRIBUTION BOX / ЭЛЕКТРОЩИТОК

8'Lİ SIVAÜSTÜ / SURFACE MOUNT / НАКЛАДНОЙ



BEYAZ - WHITE - БЕЛЫЙ

600 000 800



SİYAH - BLACK - ЧЁРНЫЙ

600 001 800

8'Lİ SIVAALTI / FLUSH MOUNT / ВСТРАИВАЕМЫЙ



BEYAZ - WHITE - БЕЛЫЙ

600 000 801



SİYAH - BLACK - ЧЁРНЫЙ

600 001 801

SIVAÜSTÜ	SURFACE MOUNT	НАКЛАДНОЙ
Quantity in Box	1	
Quantity in Carton	24	
Carton (N/G) Weight Kg.	10,45 / 12,36	
Carton m <sup>3</sup>	0,104	

SIVAALTI	FLUSH MOUNT	ВСТРАИВАЕМЫЙ
Quantity in Box	1	
Quantity in Carton	24	
Carton (N/G) Weight Kg.	11,16 / 9,25	
Carton m <sup>3</sup>	0,104	





SİGORTA KUTUSU / DISTRIBUTION BOX / ЭЛЕКТРОЩИТОК

16'LI SIVAÜSTÜ / SURFACE MOUNT / НАКЛАДНОЙ



BEYAZ - WHITE - БЕЛЫЙ

600 000 160



SİYAH - BLACK - ЧЁРНЫЙ

600 001 160

16'LI SIVAALTI / FLUSH MOUNT / ВСТРАИВАЕМЫЙ



BEYAZ - WHITE - БЕЛЫЙ

600 000 161



SİYAH - BLACK - ЧЁРНЫЙ

600 001 161

SIVAÜSTÜ	SURFACE MOUNT	НАКЛАДНОЙ
Quantity in Box	1	
Quantity in Carton	12	
Carton (N/G) Weight Kg.	9,12 / 10,55	
Carton m <sup>3</sup>	0,091	

SIVAALTI	FLUSH MOUNT	ВСТРАИВАЕМЫЙ
Quantity in Box	1	
Quantity in Carton	12	
Carton (N/G) Weight Kg.	7,85 / 9,27	
Carton m <sup>3</sup>	0,091	



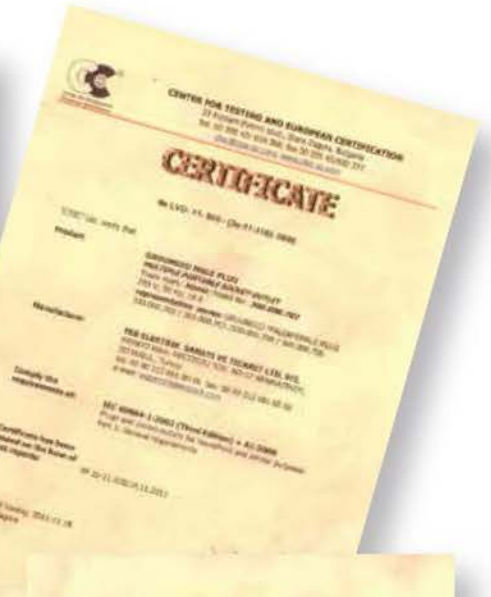

# KaçmazGrup



[www.kacmazgroup.com](http://www.kacmazgroup.com)

-   HOROZ ELECTRIC & ELECTRONIC TRADE CO. TURKEY
-   HOROZ ELECTRIC HONG KONG
-   HOROZ AYDINLATMA TURKEY
-   İREM ELEKTRİK TURKEY
-   HOROZ ELECTRIC COMPANY IRAQ
-   HOROZ ELECTRIC RUS RUSSIA
-   HOROZ EUROPE BRUSSELS BELGIUM
-   HOROZ ELECTRIC ROMANIA ROMANIA
-   HOROZ UKRAINE KIEV UKRAINE
-   HOROZ ASIA ALMATY KAZAKHSTAN
-   HOROZ KIRGHIZSTAN BISHKEK KIRGHIZSTAN
-   HOROZ AZERBAIJAN BAKU AZERBAIJAN
-   TEB ELEKTRİK TURKEY
-   ORKA CONSTRUCTION TURKEY
-   ROYAL SANAT CONSTRUCTION TURKEY
-   KORAY Bianco CONSTRUCTION TURKEY